

### GP1UM26RK0VF/GP1UM27RK0VF Series GP1UM28RK0VF/GP1UM28QK0VF Series

Anti Electromagnetic Induction  
Noise Type, Compact IR Detecting Unit  
for Remote Control

#### Features

1. Anti electromagnetic induction noise type.
2. Compact (case volume).
3. Various B.P.F. (Band-Pass Filter) frequency to meet different user needs.

#### Applications

1. AV equipments
2. Home appliances

#### Outline Dimensions

(Unit: mm)

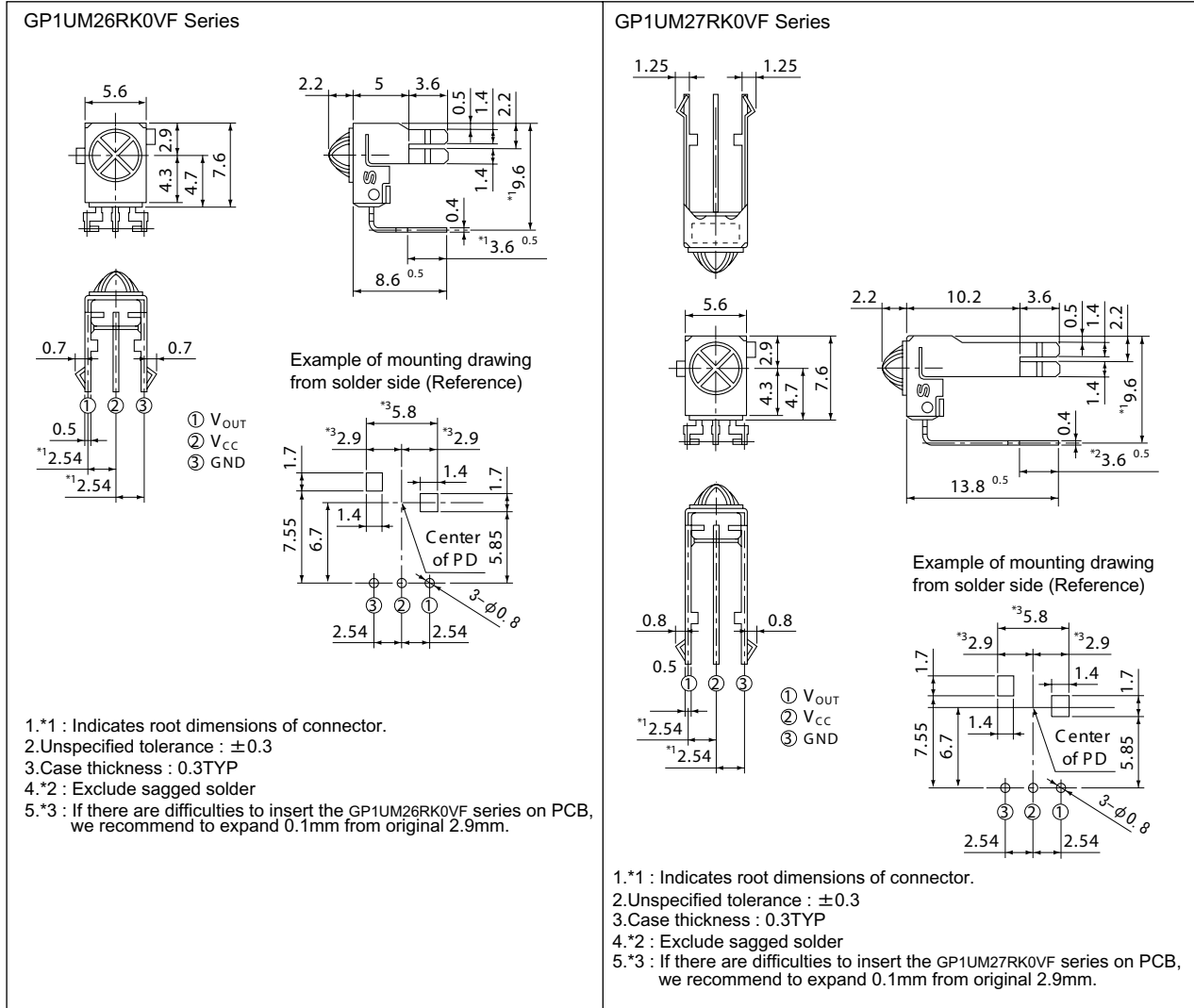

Notice The content of data sheet is subject to change without prior notice.

In the absence of confirmation by device specification sheets, SHARP takes no responsibility for any defects that may occur in equipment using any SHARP devices shown in catalogs, data books, etc. Contact SHARP in order to obtain the latest device specification sheets before using any SHARP device.

### Outline Dimensions

(Unit : mm)

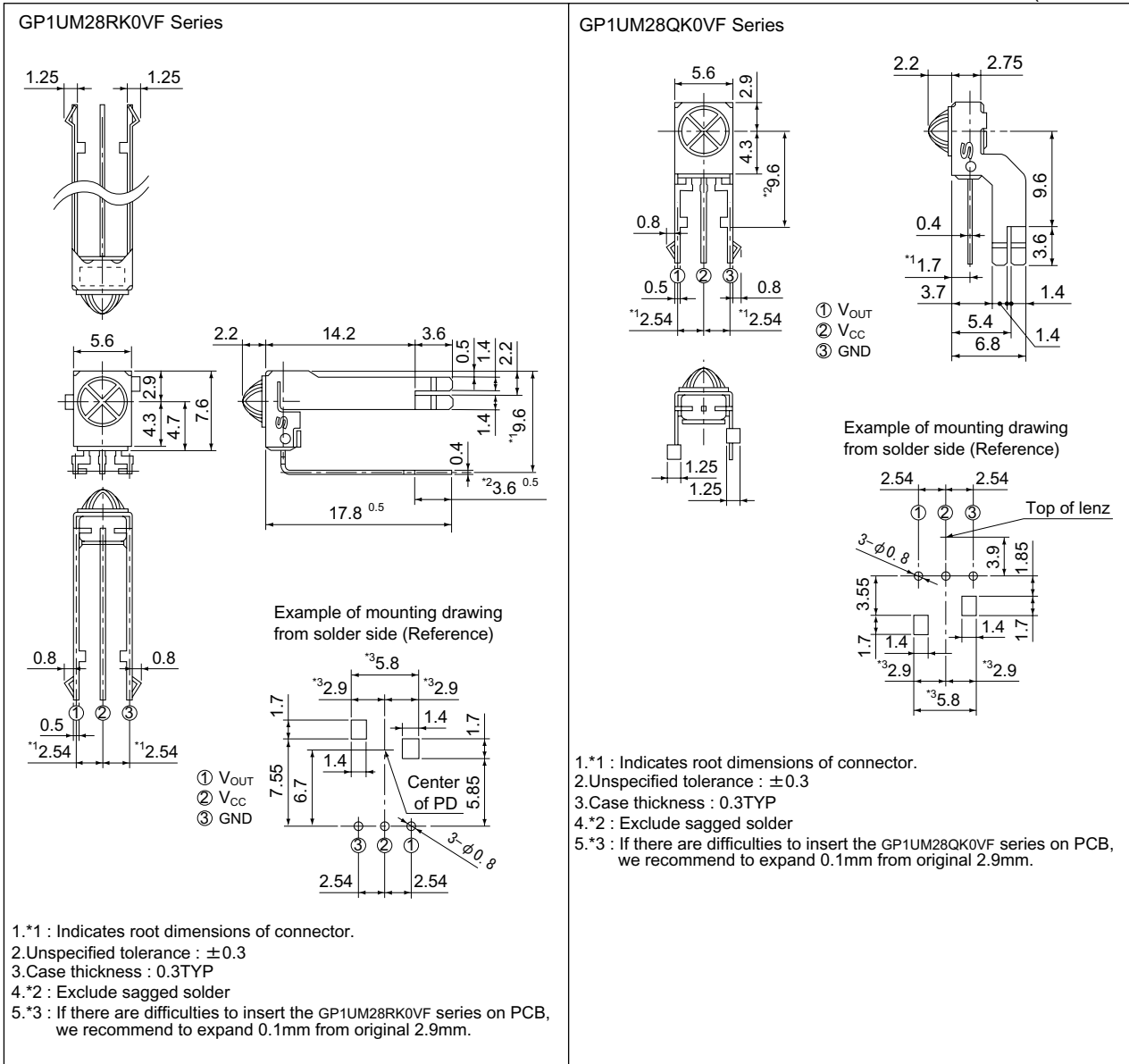

### Model Line-up

Diversified models with a different B.P.F. frequency are also available.

B.P.F. center frequency	Model No.				Unit
40	GP1UM26RK0VF	GP1UM27RK0VF	GP1UM28RK0VF	GP1UM28QK0VF	kHz
36	GP1UM260RKVF	GP1UM270RKVF	GP1UM280RKVF	GP1UM280QKVF	
38	GP1UM261RKVF	GP1UM271RKVF	GP1UM281RKVF	GP1UM281QKVF	
36.7	GP1UM262RKVF	GP1UM272RKVF	GP1UM282RKVF	GP1UM282QKVF	
32.75	GP1UM263RKVF	GP1UM273RKVF	GP1UM283RKVF	GP1UM283QKVF	
56.8	GP1UM267RKVF	GP1UM277RKVF	GP1UM287RKVF	GP1UM287QKVF	

### Internal Block Diagram

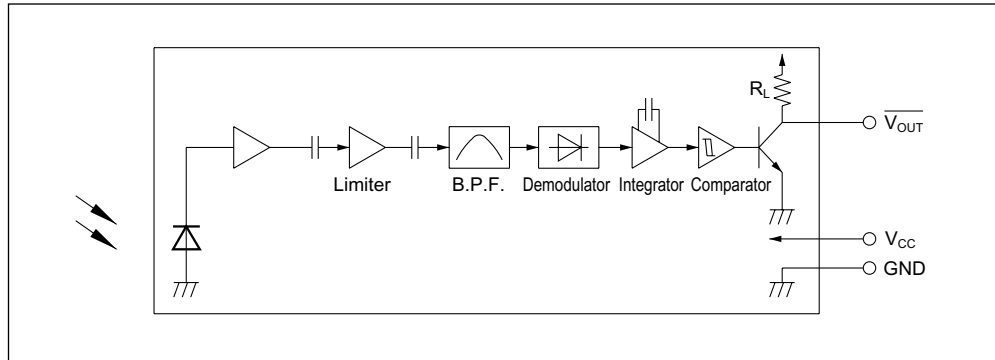

### Absolute Maximum Ratings

( $T_a=25^\circ\text{C}$ )

Parameter	Symbol	Rating	Unit
Supply voltage	$V_{CC}$	0 to +6.0	V
*1 Operating temperature	$T_{opr}$	-10 to +70	$^\circ\text{C}$
Storage temperature	$T_{stg}$	-20 to +70	$^\circ\text{C}$
*2 Soldering temperature	$T_{sol}$	260	$^\circ\text{C}$

\*1 No dew condensation is allowed

\*2 For 5s (At mounting on PCB with thickness of 1.6mm)

### Recommended Operating Conditions

Parameter	Symbol	Operating conditions	Unit
Supply voltage	$V_{CC}$	4.5 to 5.5	V

### Electro-optical Characteristics

( $T_a=25^\circ\text{C}$ ,  $V_{CC}=5\text{V}$ )

Parameter	Symbol	Conditions	MIN.	TYP.	MAX.	Unit
Dissipation current	$I_{CC}$	No input light	-	0.5	0.6(0.65) <sup>*4</sup>	mA
High level output voltage	$V_{OH}$	<sup>*3</sup>	$V_{CC}-0.5$	-	-	V
Low level output voltage	$V_{OL}$	<sup>*3</sup> $I_{OL}=1.6\text{mA}$	-	-	0.45	V
High level pulse width	$T_1$	<sup>*3</sup>	600	-	1200	$\mu\text{s}$
Low level pulse width	$T_2$	<sup>*3</sup>	400	-	1000	$\mu\text{s}$
B.P.F. center frequency	$f_0$	-	-	<sup>*5</sup>	-	kHz
Output pull-up resistance	$R_L$	-	70	100	130	k $\Omega$

<sup>\*3</sup> The burst wave as shown in the following figure shall be transmitted by the transmitter shown in Fig. 1

The carrier frequency of the transmitter, however, shall be same as <sup>\*5</sup>, and measurement shall be from just after starting the transmission until 50 pulse

<sup>\*4</sup> In case of B.P.F. center frequency  $f_0$ : 56.8kHz model

<sup>\*5</sup> The B.P.F. center frequency  $f_0$  varies with model, as shown in ■Model Line-up

Burst wave

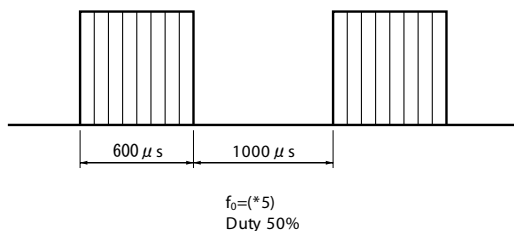

■ Performance

Using the transmitter shown in Fig. 1, the output signal of the light detecting unit is good enough to meet the following items in the standard optical system in Fig. 2.

1. Linear reception distance characteristics

When  $L=0.2$  to  $8.5(7.0)^{*6}$ m,  $^{*7}E_v < 10$  lx and  $\phi = 0^\circ$  in Fig.2, the output signal shall meet the electrical characteristics in the attached list.

2. Sensitivity angle reception distance characteristics

When  $L=0.2$  to  $6.0(4.5)^{*6}$ m,  $^{*7}E_v < 10$  lx and  $\phi \leq 30^\circ$  in Fig.2, the output signal shall meet the electrical characteristics in the attached list.

3. Anti outer peripheral light reception distance characteristics

When  $L=0.2$  to  $4.0(3.0)^{*6}$ m,  $^{*8}E_v \leq 300$  lx and  $\phi = 0^\circ$  in Fig.2, the output signal shall meet the electrical characteristics in the attached list.

\*6 In case of B.P.F. center frequency  $f_0$  :56.8kHz model

\*7 It refers to detector face illuminance

\*8 Outer peripheral light source: CIE standard light source A shall be used and placed at  $45^\circ$  from perpendicular axis at the detector face center

Fig.1 Transmitter

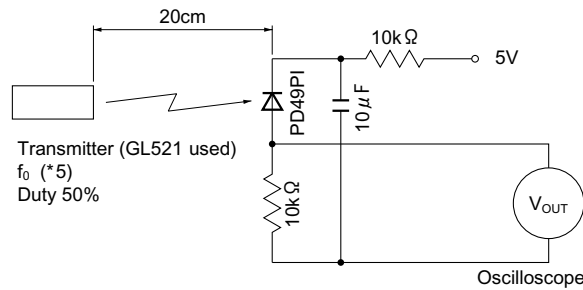

In the above figure, the transmitter should be set so that the output  $V_{OUT}$  (P-P) can be 40mV. However, the PD49PI to be used here should be of the short-circuit current  $I_{SC}=2.6 \mu A$  at  $E_v = 100$  lx. ( $E_v$  is an illuminance by CIE standard light source A (tungsten lamp).)

Fig.2 Standard Optical System

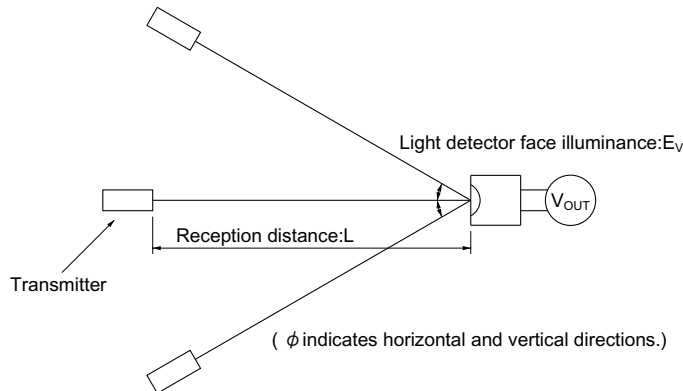

### ■ Precautions for Operation

- When this infrared remote control detecting unit shall be adopted for wireless remote control, please use the following signal format . (NEC code,RC-6code etc.)
  - Total duty ratio  $D_t$  (Emitting time  $\sum_{N=1}^n t_N$  / Transmitting time for 1 block T) : 40% or less.
  - ON signal time  $T_{ON}$  : 200  $\mu$  s or more.

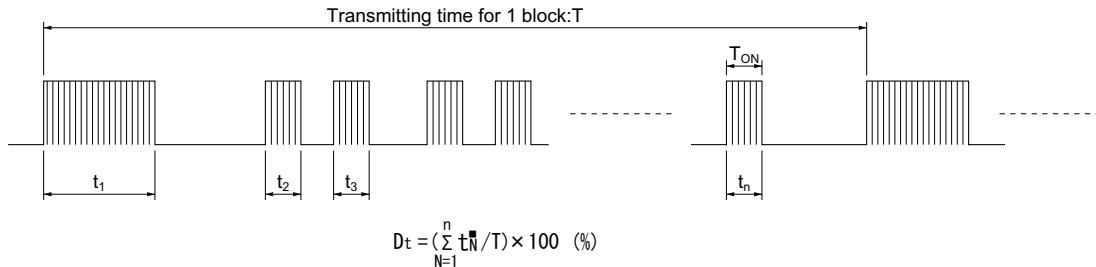

In case the signal format of total duty and/or ON/OFF signal time doesn't meet the conditions noted above, there is a case that reception distance much reduces or output dose not appear.

- Use the light emitting unit (remote control transmitter), in consideration of performance, characteristics, operating conditions of light emitting device and the characteristics of the light detecting unit.
- Pay attention to a malfunction of the light detecting unit when the surface is stained with dust and refuse. Care must be taken not to touch the light detector surface. If it should be dirty, wipe off such dust and refuse with soft cloth so as to prevent scratch. In case some solvents are required, use methyl alcohol, ethyl alcohol or isopropyl alcohol only. Also, protect the light detecting unit against flux and others, since their deposition on the unit inside causes reduction of the function, fading of markings such as the part number.
- The shield case should be grounded on PCB pattern. (The area across the shield case and the GND terminal is internally non-conductive.)
- Do not apply unnecessary force to the terminal and the case.
- Do not push the light detector surface (photodiode) from outside.
- To avoid the electrostatic breakdown of IC, handle the unit under the condition of grounding with human body, soldering iron, etc.
- Do not use hole and groove set in the case of the light detecting unit for other purposes, since they are required to maintain the specified performance.
- External Circuit Examples (Mount the outer parts as near the unit as possible).

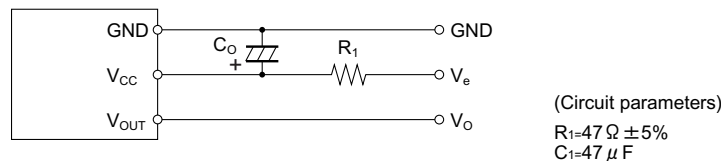

In setting  $R_1$  and  $C_1$ , use suitable values after considering under the real condition  
 The circuit constant is a example. It is difference from mounting equipment. Please select it by your mounting equipment.  
 This device has a transistor as protection element between  $V_{CC}$  and GND to improve anti-static electricity proof.  
 Please be carefully not to apply exceeding the absolute maximum ratings of applying voltage and continuous high voltage spike noise because there is cases that transistor will be short by secondary breakdown generally. In order to do difficultly, Please add CR filter( $47 \Omega$  (1/10W),  $10 \mu F$  or more) such as external circuit example above near  $V_{CC}$ .

10. There is a possibility that noise on output may be caused by environmental condition (Disturbing light noise, Electromagnetic noise, Power supply line noise, etc.) even if there is no input transmission signal.
11. Please shall confirm operation or your actual machine. Because the output pulse width of this product is fluctuated by environmental conditions such as signal format, temperature, distance from transmitter, and so on.
12. In case that this product is kept in high humidity condition, it may be hard to solder, please be careful enough about storage method.  
Depend on the flux you select, there are different solderabilities, so please select a suitable flux and use it.
13. This product dose`'t correspond to soldering by reflow.
14. Please use this device away from the dew drop.  
Be aware that the dew drop rusts shield case and others, may affect the electric characteristics.