

< Appendix >

Table of contents

1. Abstract		
1.1. Features	Attachment-3
1.2. I ² C bus interface	Attachment-4
1.2.1. Write Format	Attachment-4
1.2.2. Read Format	Attachment-4
1.2.3. Others and Notes	Attachment-4
2. Recommended operating mode/Procedure of register setting		
2.1. GS mode	Attachment-5
2.2. PS mode	Attachment-6
2.3. ALS mode	Attachment-6
2.4. GS and ALS alternating mode	Attachment-7
2.5. PS and ALS alternating mode	Attachment-8
2.6. Shutdown mode	Attachment-9
3. INT terminal output mode		
3.1. Detection result output mode for PS	Attachment-9
3.2. Interrupt output mode	Attachment-10
4. Register Mapping		
4.1. Register Mapping	Attachment-11
4.2. Precautions for Register setting	Attachment-12
4.3. Register Functions	Attachment-12
5. Register settings for Basic operation		
5.1. Operating mode selection	:OP[3],OP[1:0]	Attachment-13
5.2. Proximity detection/non-detection sensing result	:PROX	Attachment-13
5.3. Interrupt result	:FLAG_P,FLAG_A,FLAG_G	Attachment-13
5.4. INT terminal setting	:PIN[2:0]	Attachment-13
5.5. Interrupt type setting	:INTTYPE[2:0]	Attachment-13
5.6. Software reset	:RST	Attachment-13
5.7. Device ID	:ID[7:0]	Attachment-13
6. Register settings for ALS		
6.1. Resolution/Measuring duration setting for ALS mode	:RES_A [1:0]	Attachment-14
6.2. Maximum measurable range for ALS mode	:RANGE_A[3:0]	Attachment-14
6.3. ALS Detection result	:D5[15:0],D6[15:0]	Attachment-14
7. Register settings for GS and PS		
7.1. Number of measurement cycles setting	:PRST [2:0]	Attachment-15
7.2. Resolution/Measuring duration setting for PS mode	:RES_P [1:0]	Attachment-15
7.3. Maximum measurable range	:RANGE_P[2:0]	Attachment-15
7.4. LED drive peak current setting	:IS [2:0]	Attachment-15
7.5. LED pulse setting	:SUM[2:0]	Attachment-16
7.6. Gesture and Proximity low threshold (Loff)	:PL[15:0]	Attachment-16
7.7. Gesture and Proximity high threshold (Lon)	:PH[15:0]	Attachment-16
7.8. Gesture offset (Offset)	:OS_Dx[13:0]	Attachment-16
7.9. GS/PS Detection result	:D0-3[13:0],D4[15:0]	Attachment-16
7.10. Saturation Detection result of the integrator	:SATx	Attachment-17
7.11. PANEL count subtraction	:PANEL[5:0]	Attachment-17
7.12. Intermittent operating function	:INTVAL_P[2:0]	Attachment-17
7.13. Gesture interrupt number setting	:GS_INT[1:0]	Attachment-17

8. Average consumption current

- 8.1. Average consumption current with Vcc terminal Attachment-18
- 8.2. Average consumption current with VLED terminal Attachment-18

9. Example of setting sequence

- 9.1. From Power-On to operating mode Attachment-19
- 9.2. From operating mode to Power-Off Attachment-19
- 9.3. Power-On and Power-Off Attachment-19

10. Device driver

- 10.1. Device driver Attachment-20

11. Recommended Window Size (Reference)

- 11.1. Without light shield Attachment-21

12. Data (Reference)

- 12.1. LED drive peak current Attachment-22
 - 12.1.1. LED drive peak current vs. VLED (Vcc=VLED) Attachment-22
 - 12.1.2. LED drive peak current vs. Vcc (VLED=3V) Attachment-22
- 12.2. Spectral Responsivity Attachment-23
- 12.3. Proximity sensor (PS) mode Attachment-23
- 12.4. Angular dependence Attachment-24

1. Abstract

GP2AP054A00F is ambient light sensor and gesture sensor/proximity sensor with function ambient light sensing and gesture sensing / proximity sensing by setting register.

Proximity sensor (PS) mode: Judgment result of object existence can be referred by reading register value(14bit) via I²C bus interface. INT terminal can be changed either interrupt output or sensing result output (detection/non-detection status) by setting register in PS mode.

Ambient light sensor (ALS) mode: Detection result of ambient light can be referred by reading register value(16bit) via I²C bus interface. INT terminal can be changed interrupt output by setting register in PS mode.

This product is possible to operate both PS and ALS modes alternately.

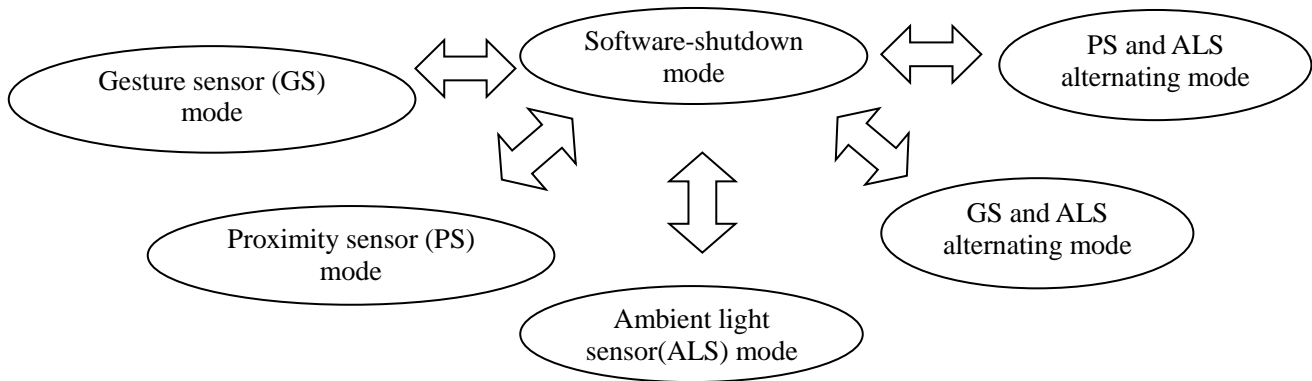

Fig.1 Operating mode of GP2AP054A00F (GS and ALS sensor)

1.1. Features

● Design

This product is composed of following two chips in one package, which is IC with a built-in photodiode (PD) (Clear (visible and infrared) photodiode and Infrared photodiode) for ambient light sensors and gesture sensors / proximity sensors, and infrared LED.

Achieving Small all-in-one package by Doubly-integrally-molded, transparent resin and light shield resin.

Spectral sensitivity(ALS) of the human eye without infrared light effects can be obtain by deducting Infrared Photodiode from Clear photodiode.

● I²C bus interface

This product has 7bit slave address adherence to I²C bus interface and can change register value for each function via I²C bus.

● INT terminal setting

INT terminal can be changed either interrupt output or sensing result output (detection/non-detection status) by setting register in PS mode. ALS mode has only interrupt output setting.

● Power save mode

Software-shutdown /Hardware-shutdown

1.2. I²C bus interface

This product has 7bit slave address adherence to I²C bus interface and can change register value for each function via I²C bus. Besides, illuminance detection result and judgment result for detection/non-detection status can be read via I²C bus.

Table 1. Terminals for I²C bus interface are as follows.

Pin Name	Description
SCL	I ² C Clock
SDA	I ² C Data bus

Basic data format are as follows.

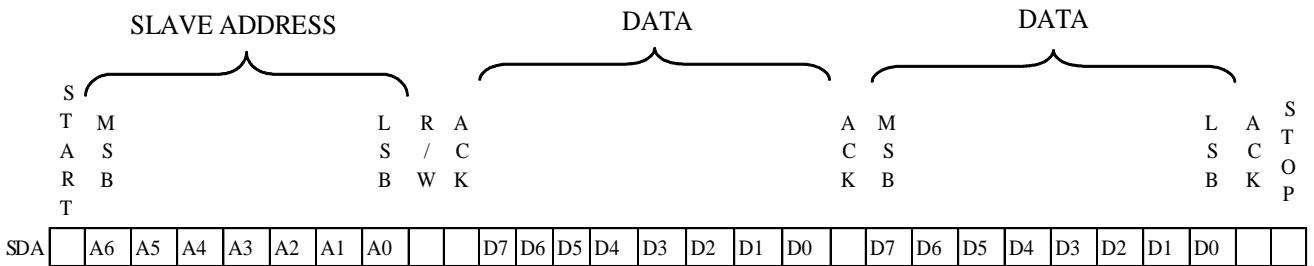

Fig.2 I²C Basic data format

DATA: Data which write into internal register/read from internal register.

SLAVE ADDRESS :

Table 2. I²C slave address

ADDRESS	A6	A5	A4	A3	A2	A1	A0	R/W
	0	1	1	1	0	0	1	X

R/W : Read:X=1, Write:X=0

1.2.1. Write Format

Write value in register and enable to write the next address sequentially after writing data. Data writing will be end with inputting stop-condition.

WordAddress:01H PROX, FLAG_P,FLAG_A and FLAG_G register in 01H are read only.

WordAddress:14H~39H D0~D6 registers from 14H to 39H are read only.

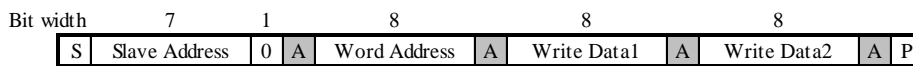

A: ACK,NA: NACK, S: START, P: STOP, X: don't care

□: Master output ■: Slave output

Fig.3 I²C write format

1.2.2. Read Format

Enable to read data in register. Following address can be read sequentially by inputting ACK after reading data. Reading data will be stopped by inputting NACK.

Stop-condition after setting Word address can be deleted since it corresponds to repeat-start-condition. Reading read data is done by not opening I²C bus interface.

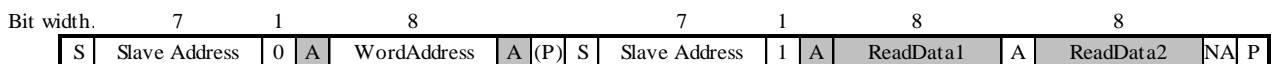

A: ACK, NA: NACK, S: START, P: STOP, X: don't care

□: Master output ■: Slave output

Fig.4 I²C read format

1.2.3. Others and Notes

This product doesn't support Clock-stretch function and General-call-address function.

2. Recommended operating mode/Procedure of register setting

When the GS mode, PS mode and ALS mode switch, please shut down and switched again.

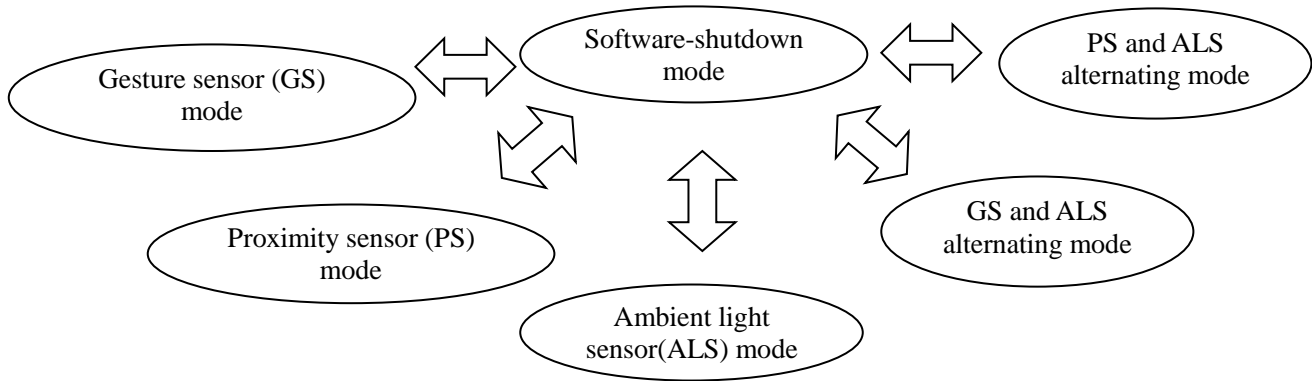

Fig.5 Recommended operating mode

2.1. Gesture sensor(GS) mode

The device can detect proximity objects by which integrates incident light in IR(infrared) photodiode during the time without emission of LED (LED off) and the time with emission of LED (LED on) in order to eliminate the influence of ambient light.

Below is an example of GS mode (Average consumption current is typical 2.1mA.),

Table 3. Example of setting for GS mode

ADDR	Register value		Register setting	Example
	bite	Hex		
01h	-	-		
02h	0100_1110	4Eh	PIN[2:0]=100 INTTYPE[2:0]=111	GS Interrupt Pulse interrupt
03h	-	-		
04h	0000_0001	01h		
05h	0110_1001	69h	PRST[2 :0]=011 RES_P[1 :0]=01 RANGE_P[2 :0]=001	PRST 4cycle 12bit x2 range
06h	1100_1101	CDh	IS[2 :0]=110 SUM[2 :0]=011	IS=150mA LED Pulse x16
07h	1111_1010	FAh	INTVAL_P[2 :0]=010	Interval time7.7msec
0Ch	0000_0000	00h	OS_D0[13 :0]=d 00	
0Dh	0000_0000	00h		
0Eh	0000_0000	00h		
0Fh	0000_0000	00h		
10h	0000_0000	00h	OS_D2[13 :0]=d 00	
11h	0000_0000	00h		
12h	0000_0000	00h	OS_D3[13 :0]=d 00	
13h	0000_0000	00h		
41h	0000_0000	00h		
00h	1010_0000	A0h	OP[3]=1 OP[1:0]=10	Active GS mode

Please enter address 00h in the end after setting 01H to 41H.

Gesture sensing results can be read at D0,D1,D2,D3[13:0],and D4[15:0] register through I²Cbus interface.

The device outputs raw data of the four IR photodiodes sensitive to only infrared spectrum gesture sensing. It is necessary for device host (user side) to get detection results with calculation of gesture values for each channel data at D0[13:0] ,D1[13:0],D2[13:0],D3[13:0] and total value of each channel data at D4[15:0].

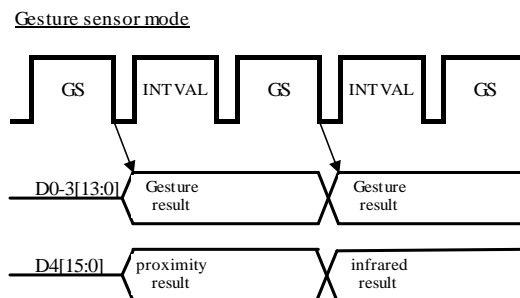

Fig.6 Output results for GS mode

2.2. Proximity sensor(PS) mode

The device can detect proximity objects by which integrates incident light in IR(infrared) photodiode during the time without emission of LED (LED off) and the time with emission of LED (LED on) in order to eliminate the influence of ambient light.

Below is an example of PS mode (Average consumption current is typical 0.8mA.)

Table 4. Example of setting for PS mode

ADDR	Register value		Register setting	Example	
	bite	Hex			
01h	-	-			
02h	0001_1110	1Eh	PIN[2:0]=001 INTTYPE[2:0]=111	PS Interrupt Pulse interrupt	
03h	-	-			
04h	0000_0001	01h			
05h	0110_1001	69h	PRST[2 :0]=011 RES_P[1 :0]=01 RANGE_P[2 :0]=001	PRST 4cycle 12bit x2 range	
06h	1100_1101	CDh	IS[2 :0]=110 SUM[2 :0]=011	IS=150mA LED Pulse x16	
07h	1111_1011	FBh	INTVAL_P[2 :0]=011	Interval time 30msec	
08h	1110_1000	E8h	PL[15 :0]=d 1000	Loff=115mm	
09h	0000_0011	03h			
0Ah	1101_1100	DCh	PH[15 :0]=d 1500	Lon=100mm	
0Bh	0000_0101	05h			
0Ch	0000_0000	00h	OS_D0[13 :0]=d 00		
0Dh	0000_0000	00h			
0Eh	0000_0000	00h	OS_D1[13 :0]=d 00		
0Fh	0000_0000	00h			
10h	0000_0000	00h	OS_D2[13 :0]=d 00		
11h	0000_0000	00h			
12h	0000_0000	00h	OS_D3[13 :0]=d 00		
13h	0000_0000	00h			
41h	0000_0000	00h			
00h	1010_0000	A0h	OP[3]=1 OP[1:0]=10	Active GS mode	

Please enter address 00h in the end after setting 01H to 41H.

Proximity sensing result can be read at D4[15:0] register through I²Cbus interface.

The device outputs interrupt signal or detection/non-detection status on INT terminal in which case D4[15:0] exceed/fall below judgment threshold level(PH[15:0]/PL[15:0]) set before sensing operation.

2.3. Ambient light sensor (ALS) mode

There are 2 photodiodes, CLEAR(sensitive to visible and infrared spectrum) and IR photodiodes (sensitive to only infrared spectrum) in this sensor. Illuminance value can be obtained by calculation from CLEAR and IR data.

Below is an example of ALS mode. (Average consumption current is typical 0.1mA.)

Table 5. Example of setting for ALS mode

ADDR	Register value		Register setting	Example	
	bite	Hex			
01h	-	-			
02h	-	-			
03h	0100_1000 ⇔ 1100_1111	48h ⇔ CFh	RES_A[1 :0]=00 RANGE_A[3 :0]= 0xxx_x000⇔1xxx_x111	18bit x1⇔x555range	Maximum detectable range(ALS)*1
04h	0000_0001	01h			
41h	0000_0000	00h			
00h	1001_0000	90h	OP[3]=b'1 OP[1:0]=b'01	Active ALS mode	

*1 The range(x1 or x555) is switched according to the D5 data.

Low_lux_mode:×1,High_lux_mode:×555

Please enter address 00h in the end after setting 01H to 41H.

Ambient light sensing results can be read at D5[15:0] and D6[15:0] register through I²C bus interface.

The device continues to execute integration operation until set measuring time(30msec, recommended) passes.

The device outputs raw data of CLEAR photodiode sensitive to both visible and infrared spectrum and IR photodiode sensitive to only infrared spectrum during ambient light sensing. It is necessary for device host (user side) to get illuminance value with calculation of both CLEAR data at D5[15:0] and IR data at D6[15:0].

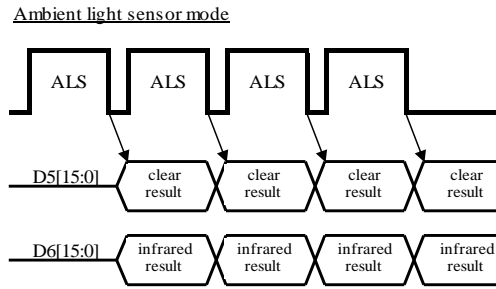

Fig.7 Output results for ALS mode

The results of without infrared light can be obtained by some calculation using D5[15:0] and D6[15:0].

$$\text{The results of without infrared light} = \alpha * D5[15:0] - \beta * D6[15:0]$$

α and β factor are decided by ratio of D6 [15:0]/D5 [15:0].

These factors might be necessary to be adjusted according to the case panel in use.

2.4. Gesture sensor(GS) and Ambient light sensor (ALS) alternating mode

This product is possible to operate both GS and ALS modes alternately.

Below is an example of GS and ALS alternating mode(Average consumption current is typical 2.2mA.)

Table 6. Example of setting for GS and ALS alternating mode

ADDR	Register value		Register setting	Example	
	bite	Hex			
01h	-	-			
02h	0100_1110	4Eh	PIN[2:0]=100 INTTYPE[2:0]=111	GS Interrupt Pulse interrupt	
03h	0100_1000 ⇔ 1100_1111	48h ⇔ CFh	RES_A[1 :0]=00 RANGE_A[3 :0]= 0xxx_x000⇔1xxx_x111	18bit x1⇔x555range	Maximum detectable range(ALS)*1
04h	0000_0001	01h			
05h	0110_1001	69h	PRST[2 :0]=011 RES_P[1 :0]=01 RANGE_P[2 :0]=001	PRST 4cycle 12bit x2 range	
06h	1100_1101	CDh	IS[2 :0]=110 SUM[2 :0]=011	IS=150mA LED Pulse x16	
07h	1111_1010	FAh	INTVAL_P[2 :0]=010	Interval time 7.7msec	At Gesture mode
0Ch	0000_0000	00h	OS_D0[13 :0]=d 00		
0Dh	0000_0000	00h			
0Eh	0000_0000	00h	OS_D1[13 :0]=d 00		
0Fh	0000_0000	00h			
10h	0000_0000	00h	OS_D2[13 :0]=d 00		
11h	0000_0000	00h			
12h	0000_0000	00h	OS_D3[13 :0]=d 00		
13h	0000_0000	00h			
41h	0000_0000	00h			
00h	1000_0000	80h	OP[3]=b'1 OP[1:0]=b'00	Active GS and ALS mode	

*1 The range(x1 or x555) is switched according to the D5 data.

Low_lux_mode:x1,High_lux_mode:x555

Please enter address 00h in the end after setting 01H to 41H.

In GS/PS and ALS alternating mode, the way of detection is as follows;

- [1]In LED on/off period, this device store a signal charge which is subtracted LEDoff period charge from LEDon period charge automatically. (Recommend setting for SUM[2:0] is 16times of LED pulses.)
- [2]In Count period, this device convert from a signal charge to digital value. (Recommend setting for RES_P[1:0] is 12bit resolution.)
- [3]Then, obtain detection result by subtracting the influence of ambient light. By using this value, proximity

sensing judgment is done if reflective object is there or not.

[4] The device integrates incident light in CLEAR photodiode and IR photodiode during a set period (recommended value:7.7msec), and then outputs the detection results to D5[15:0] and D6[15:0] respectively.

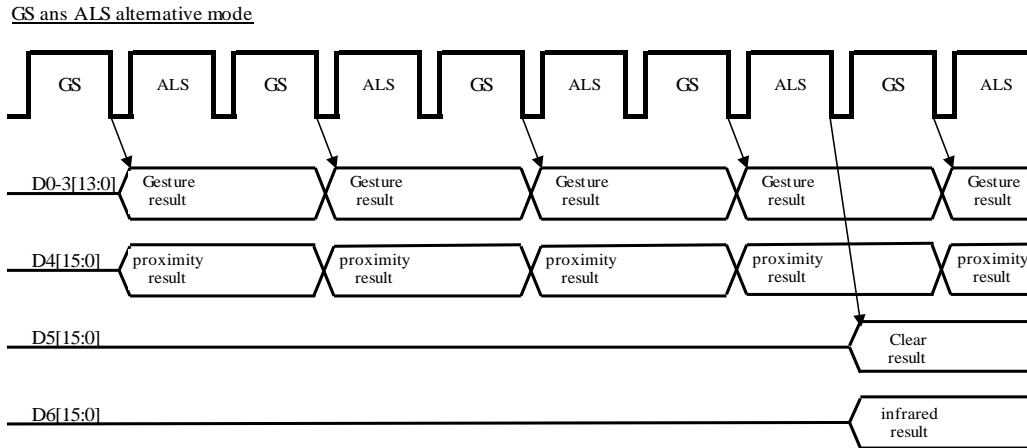

Fig.8 Output results for GS/PS and ALS alternating mode

2.5. Proximity sensor(PS) and Ambient light sensor (ALS) alternating mode

This product is possible to operate both PS and ALS modes alternately.

Below is an example of PS mode and ALS alternating mode(Average consumption current is typical 0.9mA.)

Table 7. Example of setting for PS and ALS alternating mode

ADDR	Register value		Register setting	Example	
	bite	Hex			
01h	-	-			
02h	0001_1110	1Eh	PIN[2:0]=001 INTTYPE[2:0]=111	PS Interrupt Pulse interrupt	
03h	0100_1000 ⇔ 1100_1111	48h ⇔ CFh	RES_A[1:0]=00 RANGE_A[3:0]= 0xxx_x000⇔1xxx_x111	18bit x1⇔x555range	Maximum detectable range(ALS)*1
04h	0000_0001	01h			
05h	0110_1001	69h	PRST[2:0]=011 RES_P[1:0]=01 RANGE_P[2:0]=001	PRST 4cycle 12bit x2 range	
06h	1100_1101	CDh	IS[2:0]=110 SUM[2:0]=011	IS=150mA LED Pulse x16	
07h	1111_1011	FBh	INTVAL_P[2:0]=011	Interval time 30msec	At Proximity mode
08h	1110_1000	E8h	PL[15:0]=d 1000	Loff=115mm	
09h	0000_0011	03h			
0Ah	1101_1100	DCh	PH[15:0]=d 1500	Lon=100mm	
0Bh	0000_0101	05h			
0Ch	0000_0000	00h	OS_D0[13:0]=d 00		
0Dh	0000_0000	00h			
0Eh	0000_0000	00h	OS_D1[13:0]=d 00		
0Fh	0000_0000	00h			
10h	0000_0000	00h	OS_D2[13:0]=d 00		
11h	0000_0000	00h			
12h	0000_0000	00h	OS_D3[13:0]=d 00		
13h	0000_0000	00h			
41h	0000_0000	00h			
00h	1000_0000	80h	OP[3]=b'1 OP[1:0]=b'00	Active PS and ALS mode	

*1 The range(x1 or x555) is switched according to the D5 data.

Low_lux_mode:x1,High_lux_mode:x555

Please enter address 00h in the end after setting 01H to 41H.

2.6. Shutdown mode

Control power supply to the circuit. LED drive circuit is always off in shutdown mode.

After power on, start with shutdown.

Below is an example of shutdown mode. (Average consumption current is typical 0.004mA.)

If you shut down, the INT terminal states are maintained. If the INT terminal is L level, due to the increased power consumption, it is recommended that you clear the interrupt.

Table 8. Example of setting for Shutdown mode

ADDR	Register value		Register Setting	Example
	bite	Hex		
00h	0000_0000	00h	OP[3]=b'0	Shutdown
01h	0000_0000	00h		CLEAR

3. INT terminal output mode

3.1. Proximity detection/non-detection sensing result output mode

INT terminal operates with sensing result output mode by setting PIN[2:0] register(Address 02H) 000:detection/non-detection sensing result output mode. Sensing result whether or not object is detected is able to be read out via I²C bus interface and output from INT terminal with negative logic.

Table 9. INT terminal setting (Proximity detection mode)

PIN[2:0]	Setting	Output data
000	Interrupt output for PROX(detection/non-detection)	PROX

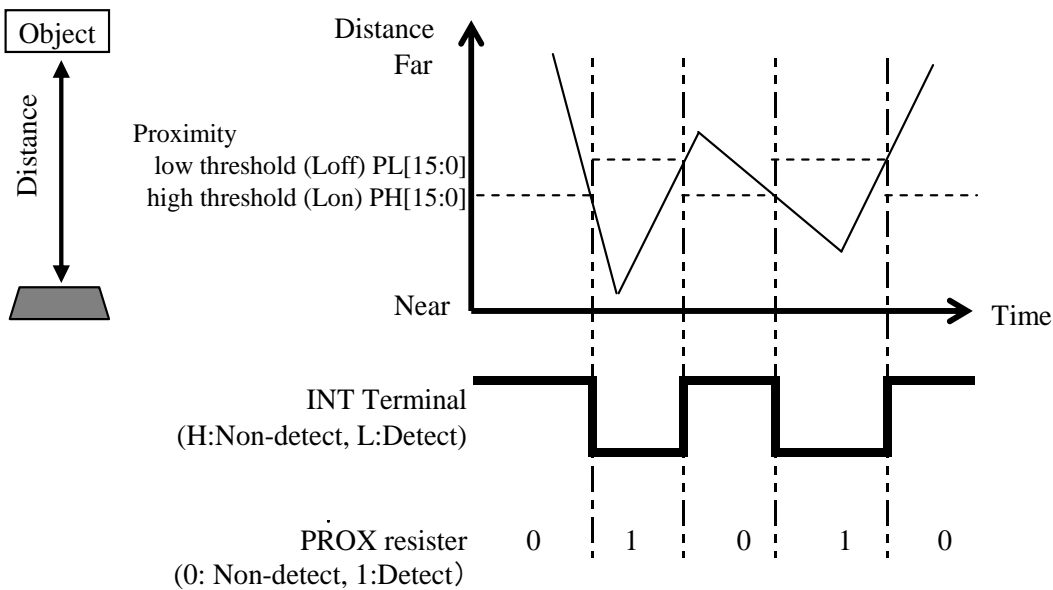

Fig.9 Detection result output mode

3.2. Interrupt output mode

Operates as interrupt output mode by setting PIN[2:0] register (Address 02H) 001,010,100: interrupt output mode.

Table 10. INT terminal setting(PIN[2:0] register)

PIN[2:0]	Setting	Output data
001	Interrupt output for PS only	FLAG_P
010	Interrupt output for ALS only	FLAG_A
100	Interrupt output for GS only	FLAG_G

There are two kinds of output mode(level interrupt & pulse interrupt) by setting INTTYPE[2:0] register (Address 02H) 000 or 111. Below is a description of the level interrupt type.

Table 11. INT terminal setting(INTTYPE[2:0] register)

INTTYPE[2:0]	Setting
000	Level interrupt
111	Pulse interrupt

000: level interrupt type

In this case, transition from H to L in INT terminal become occurring interrupt signal and INT terminal will hold L level until interrupt is cleared.

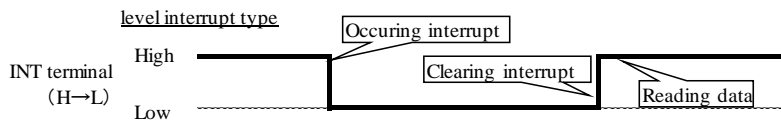

Fig.10 Interrupt output (level interrupt type)

111: pulse interrupt type

In this case, L pulse output in INT terminal become occurring interrupt signal and INT terminal will not hold L level. Therefore we need not to clear interrupt flag(FLAG_P, FLAG_A). FLAG_P and FLAG_A are cleared automatically in 1 clock (about 0.47us).

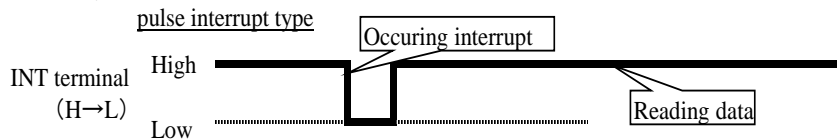

Fig.11 Interrupt output (pulse interrupt type)

The result of interrupt judgment is written into FLAG_x register (Address 01H), and is read out from I²C bus interface. (0: Non-interrupt, 1: interrupt)

In this case, transition from H to L in INT terminal become occurring interrupt signal and INT terminal will be hold L level until interrupt is cleared. Interrupt will be cleared in writing 0 data in FLAG_x register.

Detecting operation will continue while INT terminal is L level. Update ALS detection result D5[15:0],D6[15:0] and sensing result of object detection/non-detection status. Therefore, host needs to read data after FLAG_A and FLAG_P register clear.

4. Register Mapping

4.1. Register Mapping

When Vcc power is supplied, GP2AP054A00F starts up with initializing all registers.

Table 12. Register Mapping

ADDRESS	REG NAME	DATA								Initial Value	Recommend setting				
		D7	D6	D5	D4	D3	D2	D1	D0		GS	PS	ALS	GS_ALS	PS_ALS
00H	COMMAND I	OP3		OP1	OP0					H'00	H'A0	H'A0	H'90	H'80	H'80
01H	COMMAND II	FLAG_SAT3	FLAG_SAT2	FLAG_SAT1	FLAG_SAT0	PROX	FLAG_P	FLAG_A	FLAG_G	H'00	-	-	-	-	-
02H	COMMAND III	0	PIN2	PIN1	PIN0	INTTYPE2	INTTYPE1	INTTYPE0	RST	H'00	H'4E	H'1E	-	H'4E	H'1E
03H	ALS I	RANGE_A3	1	0	RES_A1	RES_A0	RANGE_A2	RANGE_A1	RANGE_A0	H'00	-	-	H'4A	H'4A	H'4A
04H	ALS II	0	0	0	0	0	0	0	1	H'00	H'01	H'01	H'01	H'01	H'01
05H	PS I	PRST2	PRST1	PRST0	RES_P1	RES_P0	RANGE_P2	RANGE_P1	RANGE_P0	H'00	H'69	H'69	-	H'69	H'69
06H	PS II	IS2	IS1	IS0	SUM2	SUM1	SUM0	0	1	H'00	H'CD	H'CD	-	H'CD	H'CD
07H	PS III	1	1	GS_INT1	GS_INT0	1	INTVAL_P2	INTVAL_P1	INTVAL_P0	H'00	H'EA	H'EB	-	H'EA	H'EB
08H	PS_LT_LSB	PL7	PL6	PL5	PL4	PL3	PL2	PL1	PL0	H'00	-	H'E8	-	-	H'E8
09H	PS_LT_MSB	PL15	PL14	PL13	PL12	PL11	PL10	PL9	PL8	H'00	-	H'03	-	-	H'03
0AH	PS_HT_LSB	PH7	PH6	PH5	PH4	PH3	PH2	PH1	PH0	H'FF	-	H'DC	-	-	H'DC
0BH	PS_HT_MSB	PH15	PH14	PH13	PH12	PH11	PH10	PH9	PH8	H'FF	-	H'05	-	-	H'05
0CH	OS_DATA0_LSB	OS_D0_7	OS_D0_6	OS_D0_5	OS_D0_4	OS_D0_3	OS_D0_2	OS_D0_1	OS_D0_0	H'00	H'00	H'00	-	H'00	H'00
0DH	OS_DATA0_MSB			OS_D0_13	OS_D0_12	OS_D0_11	OS_D0_10	OS_D0_9	OS_D0_8	H'00	H'00	H'00	-	H'00	H'00
0EH	OS_DATA1_LSB	OS_D1_7	OS_D1_6	OS_D1_5	OS_D1_4	OS_D1_3	OS_D1_2	OS_D1_1	OS_D1_0	H'00	H'00	H'00	-	H'00	H'00
0FH	OS_DATA1_MSB			OS_D1_13	OS_D1_12	OS_D1_11	OS_D1_10	OS_D1_9	OS_D1_8	H'00	H'00	H'00	-	H'00	H'00
10H	OS_DATA2_LSB	OS_D2_7	OS_D2_6	OS_D2_5	OS_D2_4	OS_D2_3	OS_D2_2	OS_D2_1	OS_D2_0	H'00	H'00	H'00	-	H'00	H'00
11H	OS_DATA2_MSB			OS_D2_13	OS_D2_12	OS_D2_11	OS_D2_10	OS_D2_9	OS_D2_8	H'00	H'00	H'00	-	H'00	H'00
12H	OS_DATA3_LSB	OS_D3_7	OS_D3_6	OS_D3_5	OS_D3_4	OS_D3_3	OS_D3_2	OS_D3_1	OS_D3_0	H'00	H'00	H'00	-	H'00	H'00
13H	OS_DATA3_MSB			OS_D3_13	OS_D3_12	OS_D3_11	OS_D3_10	OS_D3_9	OS_D3_8	H'00	H'00	H'00	-	H'00	H'00
14H	PRE3_DATA0_LSB	PRE3_D0_7	PRE3_D0_6	PRE3_D0_5	PRE3_D0_4	PRE3_D0_3	PRE3_D0_2	PRE3_D0_1	PRE3_D0_0	H'00					
15H	PRE3_DATA0_MSB	PRE3_SAT0		PRE3_D0_13	PRE3_D0_12	PRE3_D0_11	PRE3_D0_10	PRE3_D0_9	PRE3_D0_8	H'00					
16H	PRE3_DATA1_LSB	PRE3_D1_7	PRE3_D1_6	PRE3_D1_5	PRE3_D1_4	PRE3_D1_3	PRE3_D1_2	PRE3_D1_1	PRE3_D1_0	H'00					
17H	PRE3_DATA1_MSB	PRE3_SAT1		PRE3_D1_13	PRE3_D1_12	PRE3_D1_11	PRE3_D1_10	PRE3_D1_9	PRE3_D1_8	H'00					
18H	PRE3_DATA2_LSB	PRE3_D2_7	PRE3_D2_6	PRE3_D2_5	PRE3_D2_4	PRE3_D2_3	PRE3_D2_2	PRE3_D2_1	PRE3_D2_0	H'00					
19H	PRE3_DATA2_MSB	PRE3_SAT2		PRE3_D2_13	PRE3_D2_12	PRE3_D2_11	PRE3_D2_10	PRE3_D2_9	PRE3_D2_8	H'00					
1AH	PRE3_DATA3_LSB	PRE3_D3_7	PRE3_D3_6	PRE3_D3_5	PRE3_D3_4	PRE3_D3_3	PRE3_D3_2	PRE3_D3_1	PRE3_D3_0	H'00					
1BH	PRE3_DATA3_MSB	PRE3_SAT3		PRE3_D3_13	PRE3_D3_12	PRE3_D3_11	PRE3_D3_10	PRE3_D3_9	PRE3_D3_8	H'00					
1CH	PRE2_DATA0_LSB	PRE2_D0_7	PRE2_D0_6	PRE2_D0_5	PRE2_D0_4	PRE2_D0_3	PRE2_D0_2	PRE2_D0_1	PRE2_D0_0	H'00					
1DH	PRE2_DATA0_MSB	PRE2_SAT0		PRE2_D0_13	PRE2_D0_12	PRE2_D0_11	PRE2_D0_10	PRE2_D0_9	PRE2_D0_8	H'00					
1EH	PRE2_DATA1_LSB	PRE2_D1_7	PRE2_D1_6	PRE2_D1_5	PRE2_D1_4	PRE2_D1_3	PRE2_D1_2	PRE2_D1_1	PRE2_D1_0	H'00					
1FH	PRE2_DATA1_MSB	PRE2_SAT1		PRE2_D1_13	PRE2_D1_12	PRE2_D1_11	PRE2_D1_10	PRE2_D1_9	PRE2_D1_8	H'00					
20H	PRE2_DATA2_LSB	PRE2_D2_7	PRE2_D2_6	PRE2_D2_5	PRE2_D2_4	PRE2_D2_3	PRE2_D2_2	PRE2_D2_1	PRE2_D2_0	H'00					
21H	PRE2_DATA2_MSB	PRE2_SAT2		PRE2_D2_13	PRE2_D2_12	PRE2_D2_11	PRE2_D2_10	PRE2_D2_9	PRE2_D2_8	H'00					
22H	PRE2_DATA3_LSB	PRE2_D3_7	PRE2_D3_6	PRE2_D3_5	PRE2_D3_4	PRE2_D3_3	PRE2_D3_2	PRE2_D3_1	PRE2_D3_0	H'00					
23H	PRE2_DATA3_MSB	PRE2_SAT3		PRE2_D3_13	PRE2_D3_12	PRE2_D3_11	PRE2_D3_10	PRE2_D3_9	PRE2_D3_8	H'00					
24H	PRE1_DATA0_LSB	PRE1_D0_7	PRE1_D0_6	PRE1_D0_5	PRE1_D0_4	PRE1_D0_3	PRE1_D0_2	PRE1_D0_1	PRE1_D0_0	H'00					
25H	PRE1_DATA0_MSB	PRE1_SAT0		PRE1_D0_13	PRE1_D0_12	PRE1_D0_11	PRE1_D0_10	PRE1_D0_9	PRE1_D0_8	H'00					
26H	PRE1_DATA1_LSB	PRE1_D1_7	PRE1_D1_6	PRE1_D1_5	PRE1_D1_4	PRE1_D1_3	PRE1_D1_2	PRE1_D1_1	PRE1_D1_0	H'00					
27H	PRE1_DATA1_MSB	PRE1_SAT1		PRE1_D1_13	PRE1_D1_12	PRE1_D1_11	PRE1_D1_10	PRE1_D1_9	PRE1_D1_8	H'00					
28H	PRE1_DATA2_LSB	PRE1_D2_7	PRE1_D2_6	PRE1_D2_5	PRE1_D2_4	PRE1_D2_3	PRE1_D2_2	PRE1_D2_1	PRE1_D2_0	H'00					
29H	PRE1_DATA2_MSB	PRE1_SAT2		PRE1_D2_13	PRE1_D2_12	PRE1_D2_11	PRE1_D2_10	PRE1_D2_9	PRE1_D2_8	H'00					
2AH	PRE1_DATA3_LSB	PRE1_D3_7	PRE1_D3_6	PRE1_D3_5	PRE1_D3_4	PRE1_D3_3	PRE1_D3_2	PRE1_D3_1	PRE1_D3_0	H'00					
2BH	PRE1_DATA3_MSB	PRE1_SAT3		PRE1_D3_13	PRE1_D3_12	PRE1_D3_11	PRE1_D3_10	PRE1_D3_9	PRE1_D3_8	H'00					
2CH	DATA0_LSB	D0_7	D0_6	D0_5	D0_4	D0_3	D0_2	D0_1	D0_0	H'00					
2DH	DATA0_MSB	SAT0		D0_13	D0_12	D0_11	D0_10	D0_9	D0_8	H'00					
2EH	DATA1_LSB	D1_7	D1_6	D1_5	D1_4	D1_3	D1_2	D1_1	D1_0	H'00					
2FH	DATA1_MSB	SAT1		D1_13	D1_12	D1_11	D1_10	D1_9	D1_8	H'00					
30H	DATA2_LSB	D2_7	D2_6	D2_5	D2_4	D2_3	D2_2	D2_1	D2_0	H'00					
31H	DATA2_MSB	SAT2		D2_13	D2_12	D2_11	D2_10	D2_9	D2_8	H'00					
32H	DATA3_LSB	D3_7	D3_6	D3_5	D3_4	D3_3	D3_2	D3_1	D3_0	H'00					
33H	DATA3_MSB	SAT3		D3_13	D3_12	D3_11	D3_10	D3_9	D3_8	H'00					
34H	DATA4_LSB	D4_7	D4_6	D4_5	D4_4	D4_3	D4_2	D4_1	D4_0	H'00					
35H	DATA4_MSB	D4_15	D4_14	D4_13	D4_12	D4_11	D4_10	D4_9	D4_8	H'00					
36H	DATA5_LSB	D5_7	D5_6	D5_5	D5_4	D5_3	D5_2	D5_1	D5_0	H'00					
37H	DATA5_MSB	D5_15	D5_14	D5_13	D5_12	D5_11	D5_10	D5_9	D5_8	H'00					
38H	DATA6_LSB	D6_7	D6_6	D6_5	D6_4	D6_3	D6_2	D6_1	D6_0	H'00					
39H	DATA6_MSB	D6_15	D6_14	D6_13	D6_12	D6_11	D6_10	D6_9	D6_8	H'00					
3EH	ID	0	1	1	0	0	0	0	0	H'60					
41H	PANEL	0	0	PANEL5	PANEL4	PANEL3	PANEL2	PANEL1	PANEL0	H'00	H'00	H'00	H'00	H'00	H'00

4.2. Precautions for Register setting

- Please start setting registers after power-supply voltage becomes stable up to 90% or more set value.
Please wait for some 1msec before setting registers from power-on.
- PROX, FLAG_P, FLAG_A and FLAG_G registers are able to be cleared by writing 0 data in each register.
(but these registers can't be written 1 data.)
- Please don't set the address 42H and the larger ones. (Test registers are assigned in those addresses)

4.3. Register Functions

Functions and set contents of the registers are shown below.

Table 13. description of the register function

ADDR	register	function	setting
00H	OP3	Software shutdown	0:shutdown, 1:operation
	OP[1:0]		
01H	FLAG_SAT[3:0]		
	PROX	detection/non-detection	0:non-detection, 1:detection
	FLAG_P	PS interrupt result	0:non-interrupt, 1:interrupt
	FLAG_A	ALS interrupt result	0:non-interrupt, 1:interrupt
02H	FLAG_G	GS interrupt result	0:non-interrupt, 1:interrupt
	PIN[2:0]	INT terminal setting	000:PS(Detection/Non-detection),--1:FLAG_P,-1-:FLAG_A,1--:FLAG_G
	INTTYPE[2:0]	Interrupt type setting	000:level, 111:pulse
03H	RST	Software Reset	0:not reset, 1:reset
	RES_A[1:0]	Resolution	00:18bits(123msec),01:16bits(30msec),10:14bits(7.7msec),11:12bits(1.9msec)
05H	RANGE_A[0]	Maximum measurable range	0000:x1 - 0111:x138, 1110:X277, 1111:X555
	PRST[2:0]	Number of measurement cycles	000:once - 111:8cycles
06H	RES_P[1:0]	Resolution	00:14bits(7.7msec),01:12bits(1.9msec),10:10bits(0.48msec),11:8bits(0.12msec)
	RANGE_P[2:0]	Maximum measurable range	001:x2, 010:x4, 011:x8, 100:x16
07H	IS[2:0]	LED drive peak current setting	000:0mA, 100:38mA, 101:75mA, 110:150mA, 111:280mA,
	SUM[2:0]	LED pulse setting	000:x4, 001:X8, 010:X12, 011:x16, 100:X20, 101:X24, 110:x28, 111:x32
08H,09H	INTVAL_P[2:0]	GS Intermittent operating	000:0msec, 001:1.9msec, 010:7.7msec, 011:30msec, 100:61msec, 101:123msec, 110:246msec, 111:492msec
	GS_INT[1:0]	GS interrupt number	00:every-1times, 01:every-2times, 10:every-3times, 11:every-4times,
0AH,0BH	PL	Low threshold setting(Loff)	16bits counts setting
0CH,0DH	PH	High threshold setting(Lon)	16bits counts setting
0EH,0FH	OS_DATA0	DATA0 offset count(Offset0)	14bits counts setting
10H,11H	OS_DATA1	DATA1 offset count(Offset1)	14bits counts setting
12H,13H	OS_DATA2	DATA2 offset count(Offset2)	14bits counts setting
14H,15H	OS_DATA3	DATA3 offset count(Offset3)	14bits counts setting
16H,17H	PRE3_D0	Data0 of the previous three	14bits output data of GS Photodiode0
18H,19H	PRE3_D1	Data1 of the previous three	14bits output data of GS Photodiode1
1AH,1BH	PRE3_D2	Data2 of the previous three	14bits output data of GS Photodiode2
1CH,1DH	PRE3_D3	Data3 of the previous three	14bits output data of GS Photodiode3
1EH,1FH	PRE2_D0	Data0 of the previous two	14bits output data of GS Photodiode0
20H,21H	PRE2_D1	Data1 of the previous two	14bits output data of GS Photodiode1
22H,23H	PRE2_D2	Data2 of the previous two	14bits output data of GS Photodiode2
24H,25H	PRE2_D3	Data3 of the previous two	14bits output data of GS Photodiode3
26H,27H	PRE1_D0	Data0 of the previous one	14bits output data of GS Photodiode0
28H,29H	PRE1_D1	Data1 of the previous one	14bits output data of GS Photodiode1
2AH,2BH	PRE1_D2	Data2 of the previous one	14bits output data of GS Photodiode2
2CH,2DH	PRE1_D3	Data3 of the previous one	14bits output data of GS Photodiode3
2EH,2FH	D0	DATA0 result	14bits output data of GS Photodiode0
30H,31H	D1	DATA1 result	14bits output data of GS Photodiode1
32H,33H	D2	DATA2 result	14bits output data of GS Photodiode2
34H,35H	D3	DATA3 result	14bits output data of GS Photodiode3
36H,37H	D4	DATA0-DATA3 sum	16bits output data of PS all Photodiode(D4=D0+D1+D2+D3)
38H,39H	D5	DATA5 result	16bits output data of CLR Photodiode
3EH	D6	DATA6 result	16bits output data of IR Photodiode
41H	ID[7:0]	Device ID	0110_0000
41H	PANEL[5:0]	PANEL count Subtraction	PANEL[5:3]:D0,D3 count Subtraction,PANEL[2:0]:D1,D2 count Subtraction

5. Register settings for Basic operation

5.1. Operating mode selection: OP [3],OP [1:0] (ADDRESS:00H)

Select Software shutdown or ALS or GS(PS) or alternating mode(GS(PS) + ALS).

OP [3],OP[1:0] register (Address 00H)

0x00: Software shutdown

Control power supply to the circuit. LED drive circuit is always off in shutdown mode.

After power on, start with shutdown

1x00: GS(PS) and ALS alternating

1x01: ALS mode

Detection result of clear photodiode is output to D5[15:0] register (Address 36H, 37H).

Detection result of infrared photodiode is output to D6[15:0] register (Address 38H, 39H).

1x10: GS(PS) mode

Sensing result of detection/non-detection is output to PROX register(Address 01H).

Detection result of distance is output to D4[15:0] register (Address 34H, 35H).

5.2. Proximity detection/non-detection: PROX (ADDRESS 01H)

Sensing result for detection/non-detection is output. There is a function which clears data by writing 0 in PROX register.

PROX register(Address 01H): 0: non-detection, 1: detection

5.3. Interrupt result: FLAG_P,FLAG_A,FLAG_G (ADDRESS 01H)

FLAG_P register is output interrupt result for PS mode.

FLAG_A register is output interrupt result for ALS mode.

FLAG_G register is output interrupt result for GS mode.

There is a function which clears by writing 0 in FLAG register.

FLAG register (Address 01H) : 0: non-interrupt, 1: interrupt

5.4. INT terminal setting: PIN[2:0] (ADDRESS 02H)

Select output mode in INT terminal by setting PIN register (Address 02H).

The outputs by PROX, FLAG_P, FLAG_A and FLAG_G can be selected.

Table 14. INT terminal setting

PIN[2:0]	Setting	Output data
000	Interrupt output for PROX(detection/non-detection)	PROX
001	Interrupt output for PS only	FLAG_P
010	Interrupt output for ALS only	FLAG_A
100	Interrupt output for GS only	FLAG_G

5.5. Interrupt type setting (for PS,ALS,GS) : INTTYPE[2:0] (ADDRESS:02H)

Select level interrupt type or pulse interrupt type by setting INTTYPE register (Address 02H).

Table 15. INT terminal setting(INTTYPE[2:0] register)

INTTYPE[2:0]	Setting
000	Level interrupt
111	Pulse interrupt

5.6. Software reset: RST (ADDRESS 02H)

Initialize all registers by writing 1 in RST register. RST register is also initialized automatically and becomes 0.

5.7. Device ID : ID[7:0] (ADDRESS 3EH)

Device Identification Register is 0110_0000(60h).

6. Register settings for ALS

6.1. Resolution/Measuring duration setting for ALS mode: RES_A [1:0] (ADDRESS 03H)

Select measuring resolution and measuring duration for ALS mode by setting RES_A [1:0] register (Address 03H). If resolution is low, measuring tolerance becomes large. Please have an adjustment at your system.

Table 16. Resolution/Measuring duration setting for ALS mode

RES_A[1:0]	Resolution	Measuring time	Remarks
		ALS mode	
00	18bit	123msec	recommended
01	16bit	30msec	
10	14bit	7.7msec	
11	12bit	1.9msec	

* Grayed-out portions is not recommended.

6.2. Maximum measurable range for ALS mode: RANGE_A [3:0] (ADDRESS 03H)

Select maximum measurable range for ALS mode by setting RANGE_A [3:0] register (Address 03H).

Detect with a set range in ALS mode. Maximum count value is outputted in case of incident light exceeding maximum measurable range.

It is possible to have countermeasure for external light by setting a large count value at maximum measurable range.

It is necessary to set them considering the condition in the actual use and evaluating at your system.

Table 17. Maximum measurable range for ALS mode

RANGE_A[3:0]	Maximum measurable range	Remarks
	ALS mode	
0xxx_x000	×1	
0xxx_x001	×2	
0xxx_x010	×4	
0xxx_x011	×8	
0xxx_x100	×16	
0xxx_x101	×32	
0xxx_x110	×64	
0xxx_x111	×138	
1xxx_x110	×277	
1xxx_x111	×555	

6.3. ALS Detection result: D5 [15:0], D6 [15:0] (ADDRESS 36H,37H,38H,39H)

Detection result of clear photodiode is output to D5[15:0] register (Address 36H, 37H).

Detection result of infrared photodiode is output to D6[15:0] register (Address 38H, 39H).

The results of without infrared light can be obtained by some calculation using D5[15:0] and D6[15:0].

$$\text{The results of without infrared light} = \alpha * D5[15:0] - \beta * D6[15:0]$$

α and β factor are decided by ratio of D6 [15:0]/D5 [15:0].

These factors might be necessary to be adjusted according to the case panel in use.

7. Register settings for GS and PS

7.1. Number of measurement cycles setting: PRST[2:0] (ADDRESS:05H)

Select number of measurement cycles by setting PRST[2:0] register. Judgment result for detection/non-detection is over threshold continuously more than the set cycles in PRST[2:0] register. This judgment result is done in using the detection result of distance (D4[15:0]).

Table 18. Number of measurement cycles setting

PRST[2:0]	Persistence Cycle	Remarks
000	1cycle	recommended(gesture)
001	2cycles	
010	3cycles	
011	4cycles	
100	5cycles	
101	6cycles	
110	7cycles	
111	8cycles	

- Algorithm for detecting object in PS is as follows.

<Judge the change from non-detecting status to detecting status>

Detection result is over high threshold (Lon) N times continuously : Detection

Other : Non-detection

<Judge the change from detecting status to non-detecting status>

Detection result is over low threshold (Loff) N times continuously : Non-Detection

Other : Detection

7.2. Resolution/Measuring duration setting: RES_P [1:0] (ADDRESS 05H)

Select measuring resolution and measuring duration by setting RES_P[1:0] register (Address 05H). If resolution is low, measuring tolerance becomes large. Please have an adjustment at your system.

Table 19. Resolution/Measuring duration setting

RES_P[1:0]	Resolution	Measuring duration	Remarks
00	14bit	7.7msec	
01	12bit	1.9msec	recommended
10	10bit	0.48msec	
11	8bit	0.12msec	

* Grayed-out portions is not recommended.

7.3. Maximum measurable range: RANGE_P[2:0] (ADDRESS 05H)

Select maximum measurable range by setting RANGE [2:0] register (Address 05H).

Detect with a set range. Maximum count value is outputted in case of incident light exceeding maximum measurable range.

Adjusting detecting distance by proximity low threshold PL[15:0] and PH[15:0]. It is necessary to set them considering the condition in the actual use and evaluating at your system.

Table 20. Maximum measurable range

RANGE_P[2:0]	Maximum measurable range	Remarks
001	×2	recommended
010	×4	
011	×8	
100	×16	

* Grayed-out portions is not recommended.

7.4. LED drive peak current setting IS[2:0] (ADDRESS 06H)

Enable to select LED drive peak current by setting IS[2:0] register (Address 06H).

In case of changing this setting, the count will change correspond to the set LED drive peak current.

Please adjust detecting distance with proximity low threshold PL[15:0] and proximity high threshold PH[15:0].

LED drive peak current will depend on Vcc and VLED voltage. (Refer to 12.1. LED drive peak current data)

Table 21. LED drive peak current

IS[2:0]	LED drive peak current	Remarks
011	19 mA	
100	38 mA	
101	75 mA	
110	150 mA	recommended
111	280 mA	

ions is not recommended.

7.5. LED pulse setting: SUM[2:0] (ADDRESS 06H)

Select LED pulse setting by setting SUM[2:0] register (Address 06H).

If LED pulse setting is low, measuring tolerance becomes large. Please have an adjustment at your system.

Number of LED pulses can be changed from 4times to 32times.

Table 22. LED pulse setting

SUM[2:0]	LED pulse setting	Remarks
000	×4 times	
001	×8 times	
010	×12 times	
011	×16 times	recommended
100	×20 times	
101	×24 times	
110	×28 times	
111	×32 times	

* Grayed-out portions is not recommended.

7.6. Gesture and Proximity low threshold (Loff):PL[15:0] (ADDRESS 08H, 09H)

Sets proximity low threshold in PL[15:0] register at PS mode.

Please set it with confirming at optical mounting condition in the actual use.

7.7. Gesture and Proximity high threshold (Lon):PH[15:0] (ADDRESS 0AH, 0BH)

Sets proximity high threshold in PH[15:0] register at PS mode.

Please set it with confirming at optical mounting condition in the actual use.

7.8. Gesture offset (Offset):OS_D0[13:0],OS_D1[13:0],OS_D2[13:0],OS_D3[13:0] (ADDRESS 0CH~13H)

Sets gesture offset in OS[13:0] register at GS mode.

If there is Panel crosstalk, you will be able to subtract the Panel crosstalk count by using gesture offset.

Please set it with confirming at optical mounting condition in the actual use.

7.9. GS Detection result: D0[13:0], D1[13:0], D2[13:0], D3[13:0] (ADDRESS 2CH~33H)

Detection result of gesture sensing is output to D0[13:0], D1[13:0], D2[13:0] and D3[13:0] register(Address 2CH~33H).

Detection result is defined as follows,

Detection result(D0[13:0]) = Raw count(D0[13:0], include panel crosstalk) – Offset(OS_D0[13:0])

Detection result(D1[13:0]) = Raw count(D1[13:0], include panel crosstalk) – Offset(OS_D1[13:0])

Detection result(D2[13:0]) = Raw count(D2[13:0], include panel crosstalk) – Offset(OS_D2[13:0])

Detection result(D3[13:0]) = Raw count(D3[13:0], include panel crosstalk) – Offset(OS_D3[13:0])

Gesture detection:

If the detected object on the right, $D0[13:0]+D3[13:0] > D1[13:0]+D2[13:0]$.

If the detected object on the left, $D0[13:0]+D3[13:0] < D1[13:0]+D2[13:0]$.

If the detected object on the top, $D0[13:0]+D1[13:0] > D2[13:0]+D3[13:0]$.

If the detected object on the bottom, $D0[13:0]+D1[13:0] < D2[13:0]+D3[13:0]$.

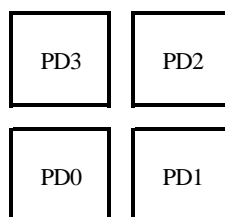

Fig.12 The built-in Photodiodes position(PD0, PD1, PD2, PD3).

Photodiode0(PD0) count value is stored to the raw count of D0[13:0].

Photodiode1(PD1) count value is stored to the raw count of D1[13:0].

Photodiode2(PD2) count value is stored to the raw count of D2[13:0].

Photodiode3(PD3) count value is stored to the raw count of D3[13:0].

7.10. Saturation Detection result of the integrator: SAT0, SAT1, SAT2, SAT3 (ADDRESS 01H)

Saturation detection result of the integrator is output to SAT0, SAT1, SAT2, SAT3 register (Address 01H).

If the integrator(PD0) is saturated, SAT0 register is set to 1.

If the integrator(PD1) is saturated, SAT1 register is set to 1.

If the integrator(PD2) is saturated, SAT2 register is set to 1.

If the integrator(PD3) is saturated, SAT3 register is set to 1.

7.11. PANEL count Subtraction: PANEL[5:0] (ADDRESS 41H)

Sets PANEL count Subtraction in PANEL[5:0] register at GS mode.

If there is Panel crosstalk, you will be able to subtract the Panel crosstalk count by using PANEL count Subtraction.

Detection result D0[13:0] and D3[13:0] is subtracted by PANEL[5:3] register.

Detection result D1[13:0] and D2[13:0] is subtracted by PANEL[2:0] register.

Please set it with confirming at optical mounting condition in the actual use.

7.12. Intermittent operating function: INTVAL_P[2:0] (ADDRESS 07H)

This function is to reduce average consumption current by stopping part of circuit intermittently, and this is different from software shutdown function. Intermittent operating duration can be changed by setting INTVAL_P[2:0] register.

Setting a longer intermittent operating duration makes LED average consumption current lower. However, update period of the detection result becomes long. It will make response time of detecting longer.

Enable to change intermittent operating periods by setting INTVAL_P [2:0] register.

Table 23. Intermittent time setting

INTVAL_P[2:0]	Intermittent time setting	Remarks
000	0msec	not allowed
001	1.9msec	not allowed
010	7.7msec	recommended
011	30msec	recommended
100	61msec	
101	123msec	
110	246msec	
111	492msec	

* Grayed-out portions is not recommended.

For GS mode, quiescent operation will be after GS operation.

For GS and ALS alternating mode, ALS operation will be after GS operation.

Although setting a longer intermittent operating period contributes to reduce average consumption current, it makes update period and response time for detection longer as a result. Need to set it considering your actual conditions in use.

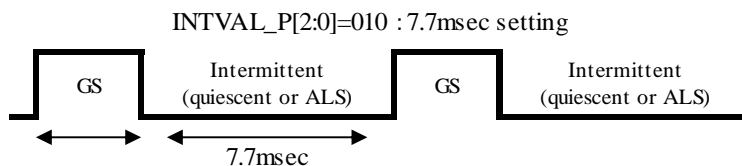

Fig.13 Intermittent operating

7.13. Gesture interrupt number setting: GS_INT[1:0] (ADDRESS 07H)

Sets gesture interrupt number in GS_INT[1:0] register at GS mode.

If gesture interrupt number setting is GS_INT[1:0]=00, Gesture interrupt becomes every-1times.

If gesture interrupt number setting is GS_INT[1:0]=11, Gesture interrupt becomes every-4times.

Please have an adjustment at your system.

Gesture interrupt number can be changed from every-1times to every-4times.

Table 24. Gesture interrupt number setting

GS_INT[1:0]	Gesture interrupt number setting	Remarks
00	every-1 times	
01	every-2 times	
10	every-3 times	
11	every-4 times	

8. Average consumption current

Average consumption current in operation is the sum of the average current consumption value with Vcc terminal and LED consumption. The LED driven current flows from LEDA terminal to GND terminal.

8.1. Average consumption current with Vcc terminal

Average consumption current at GS mode is typical 0.32mA.

Average consumption current at ALS mode is typical 0.1mA.

Average consumption current at Shutdown mode is typical 0.004mA.

8.2. Average consumption current with VLED terminal

In case of continuous operation, average consumption current in LED is estimated as below.

[LED average consumption current]

$$= \text{LED drive peak current} \times (\text{LED pulse setting} \times 7.5\text{usec}) / (\text{measuring time} + \text{Intermittence time})$$

[LED drive peak current]: IS[2:0] register.

011 : 19mA, 100 : 38mA, 101 : 75mA, 110 : 150mA

[LED pulse setting]: SUM[2:0] register.

000 : x4, 001 : x8, 010 : x12, 011 : x16, 100 : x20, 101 : x24, 110 : x28, 111 : x32

LED on/off period = 0.0225msec × SUM

[Count period] : Enable to set with RES_P[1:0] register.

00 : 7.7msec(14bit), 01 : 1.9msec(12bit), 10 : 0.48msec(10bit), 11 : 0.12msec(8bit)

[Intermittence operating time] : Enable to set with INTVAL_P[2:0] register.

000 : 0msec, 001 : 1.9msec, 010 : 7.7msec, 011 : 30msec

100 : 61msec, 101 : 123msec, 110 : 246msec, 111 : 492msec

For example,

[LED drive peak current]	: 150mA	IS[2:0]=110
[LED pulse setting]	: x16	SUM[2:0]=011
LED on/off period	: 0.36msec	
[Count period]	: 1.9msec(12bit)	RES_P[1:0]=01
[Intermittence operating time]	: 7.7msec	INTVAL_P[2:0]=010

In the above case,

$$[\text{LED averaging consumption current}] = 150\text{mA} \times 16 \times 7.5\text{usec} / (0.36\text{msec} + 1.9\text{msec} + 7.7\text{msec})$$

$$= 1.81\text{mA}$$

Also, using auto-shut down function, it will be automatically shutdown after one operation. Utilizing it with adjusting your system, it contributes to reduce averaging consumption current in LED.

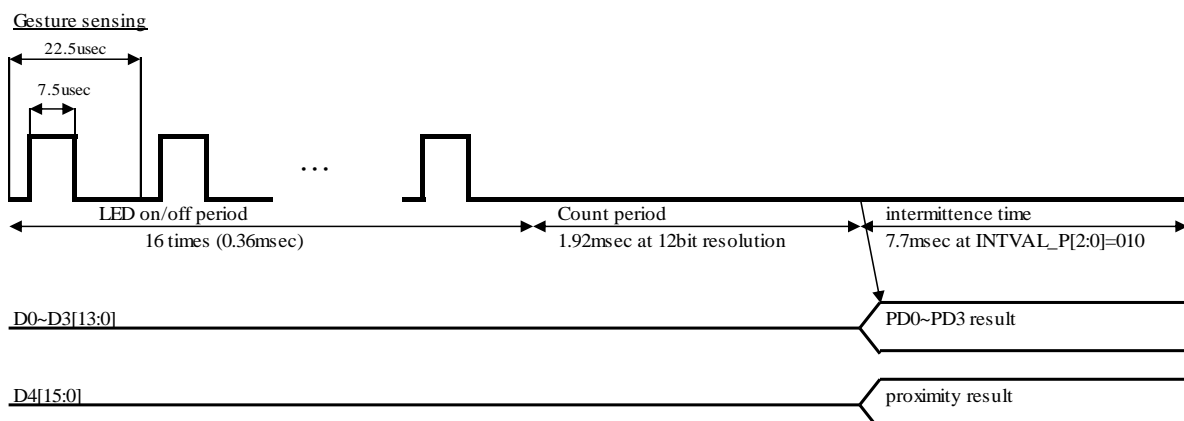

9. Example of setting sequence

9.1. From Power-On to operating condition

The internal register of GP2AP054A00F are all initialized after powering on.(Power-On-Reset)
 Insert a wait for at least 1ms until the Power-On-Reset state stabilizes.

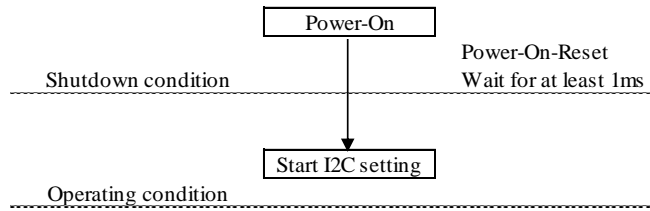

Fig.14 From Power-On to operating condition

9.2. From operating condition to Power-Off

Insert a wait for at least 1ms until shutdown state stabilizes.

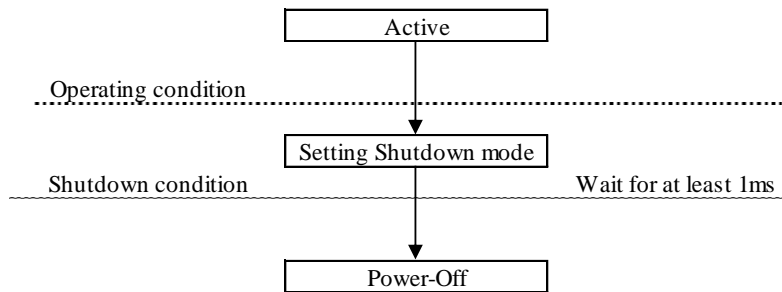

Fig.15 From operating condition to Power-Off

9.3. Power-On and Power-Off

The following figure shows configuration sequence at Power-On and Power-Off

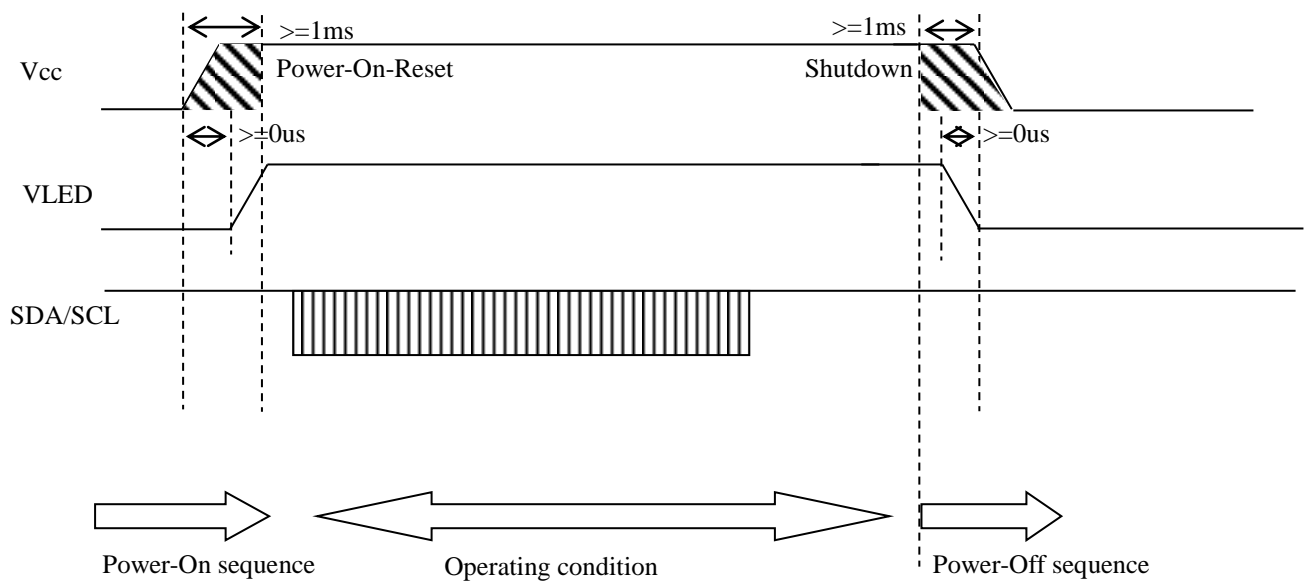

Fig.16 Power-On and Power-Off

10. Device Driver

10.1. Device Driver

We can provide a device driver for this product.

If you need support for the software, please contact me feel free.

11. Recommended Window Size (Reference)

11.1. Without light shield

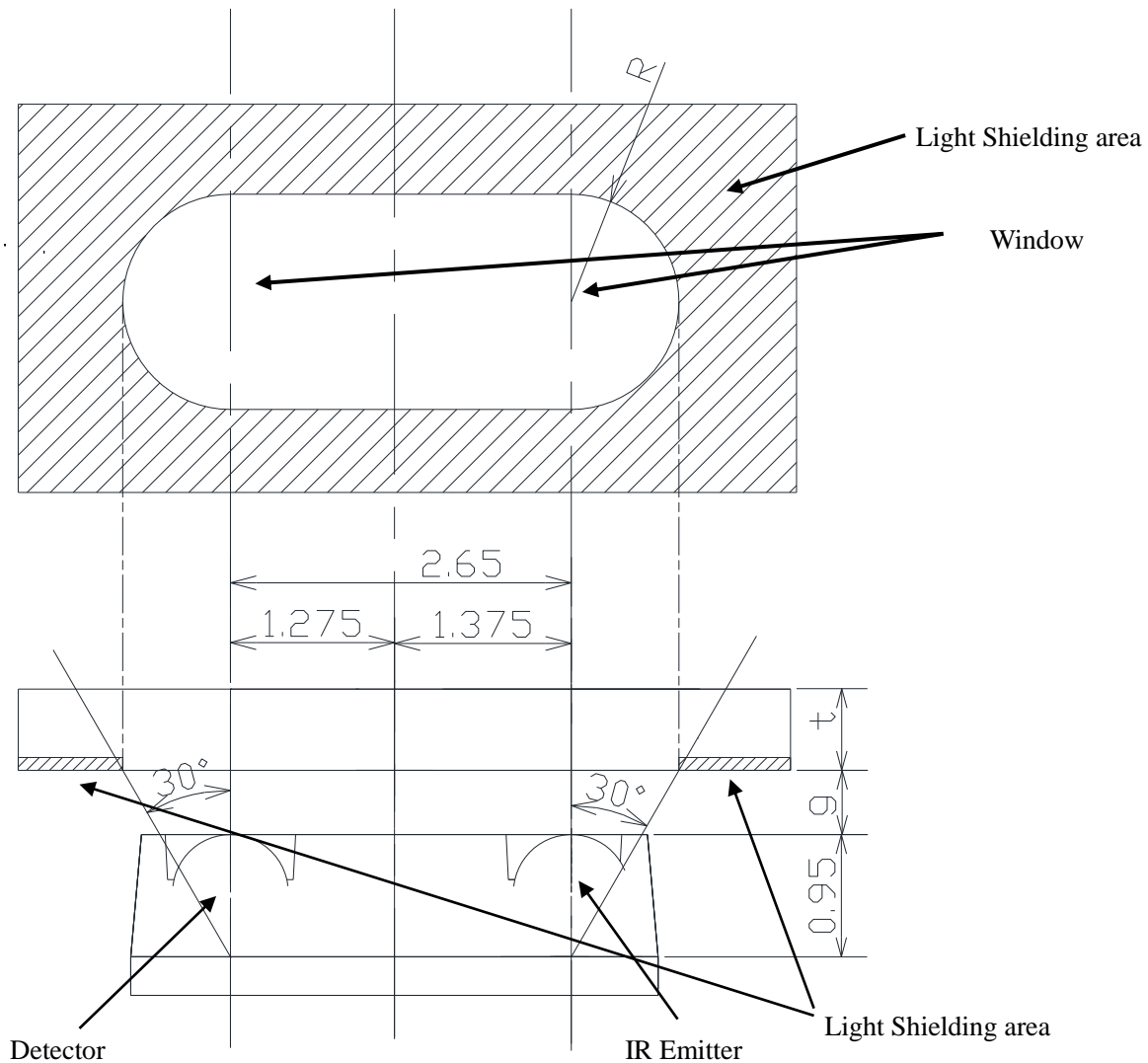

GP2AP054A00F

$$h = 0.95 \text{ mm}$$

$$Cg = (h+g) \times \tan 30^\circ$$

$$R = (h+g) \times \tan 30^\circ$$

$$g \leq 0.4 \text{ mm (recommended)} \quad g : \text{distance between sensor and panel}$$

$$t \leq 0.7 \text{ mm (recommended)} \quad t : \text{thickness of panel}$$

Fig.17 Recommended window size (Without light shield)

1. Please print or tape up not to transmit infrared.
2. Please execute the Light Shielding between windows.
3. Even recommended window size may cause malfunction depending on the reflection from the panel.
In this case, it is effective to be extended the printing area between windows, but affects detection distance and ALS output.
4. Please confirm that there is no problem with an actual machine in consideration of the implementation gap, the misalignment of the windows and voltage variation.
5. The recommended transmissivity ($400\text{nm} \leq \lambda \leq 1100\text{nm}$) of the window is more than 85%.

12. Data (Reference)

12.1. LED drive peak current

12.1.1. LED drive peak current vs. VLED (Vcc=3V)

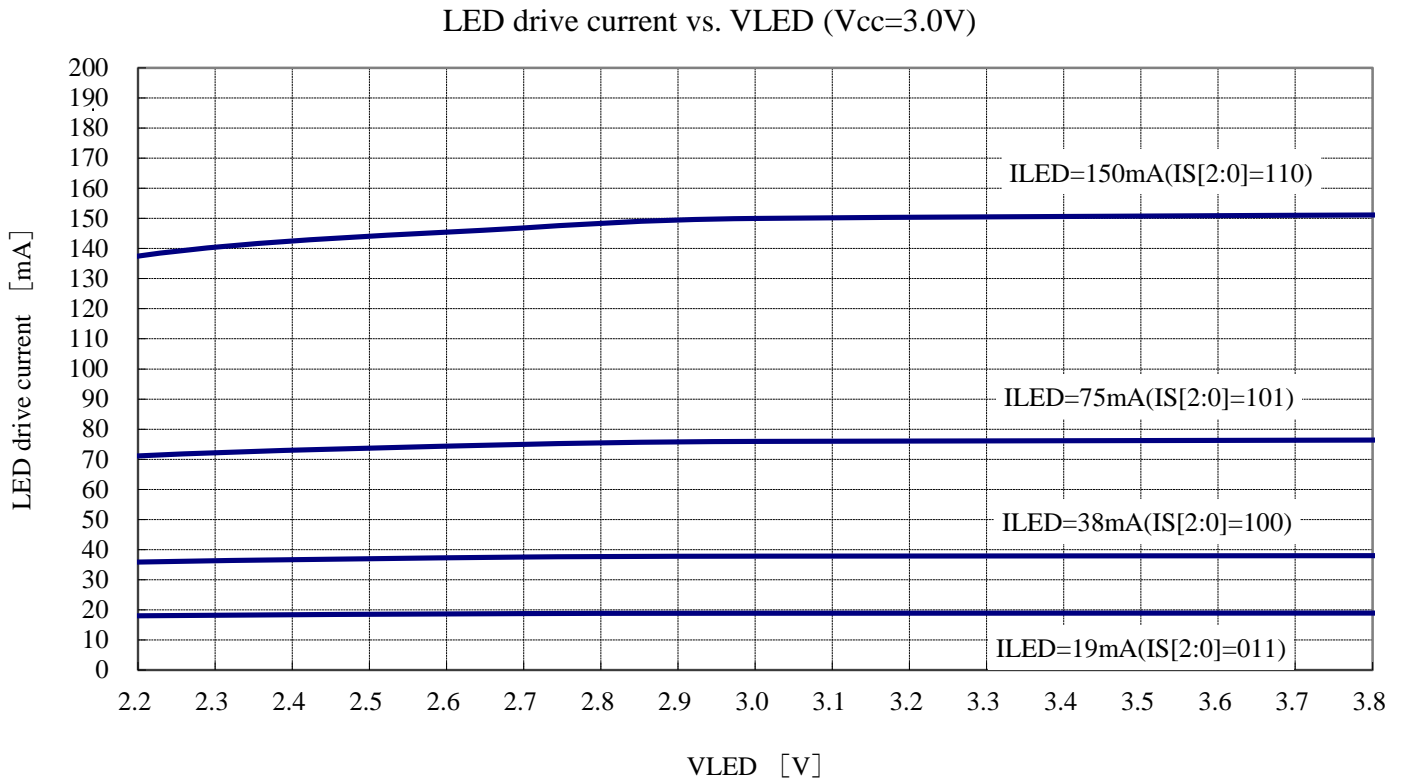

Fig.18 LED drive peak current vs. VLED

12.1.2. LED drive peak current vs. Vcc (VLED=3V)

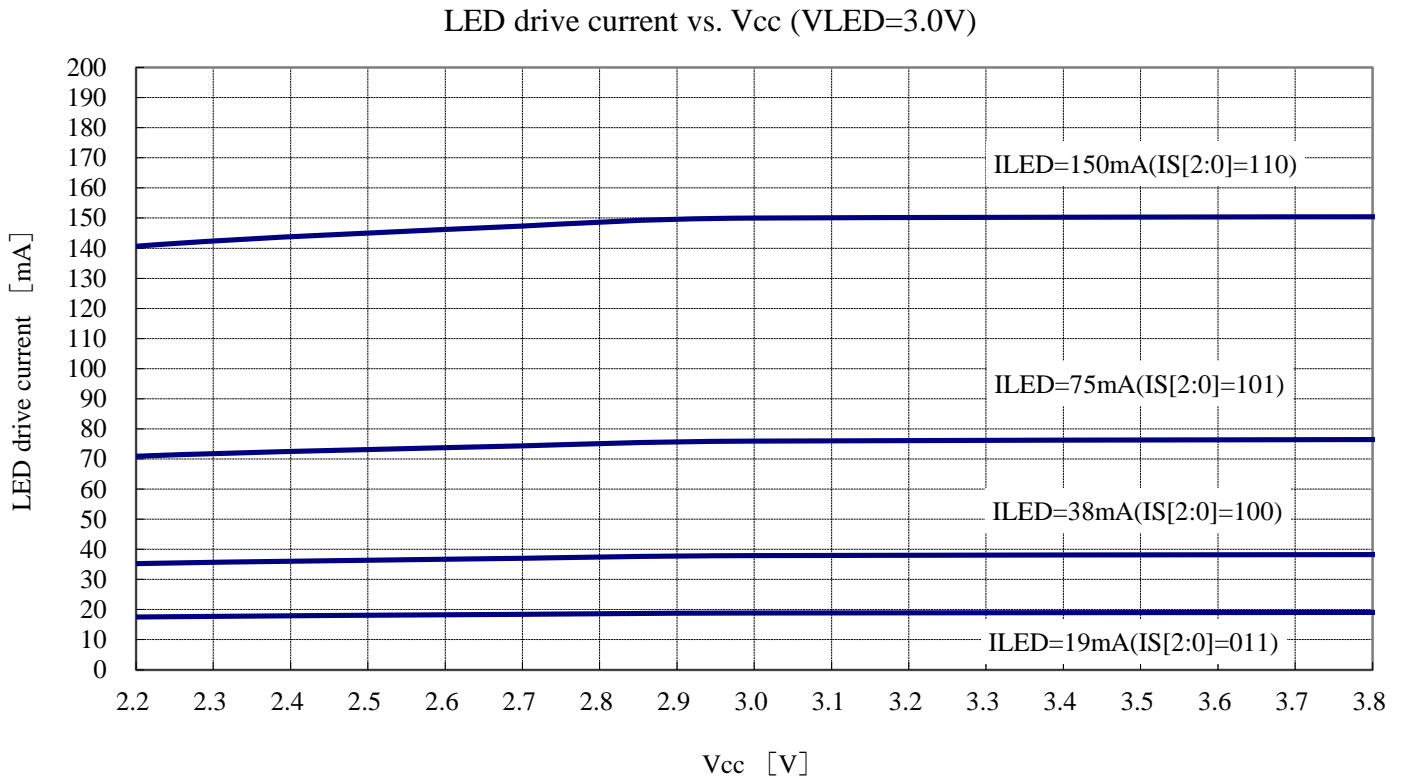

Fig.19 LED drive peak current vs. Vcc

12.2. Spectral Responsivity

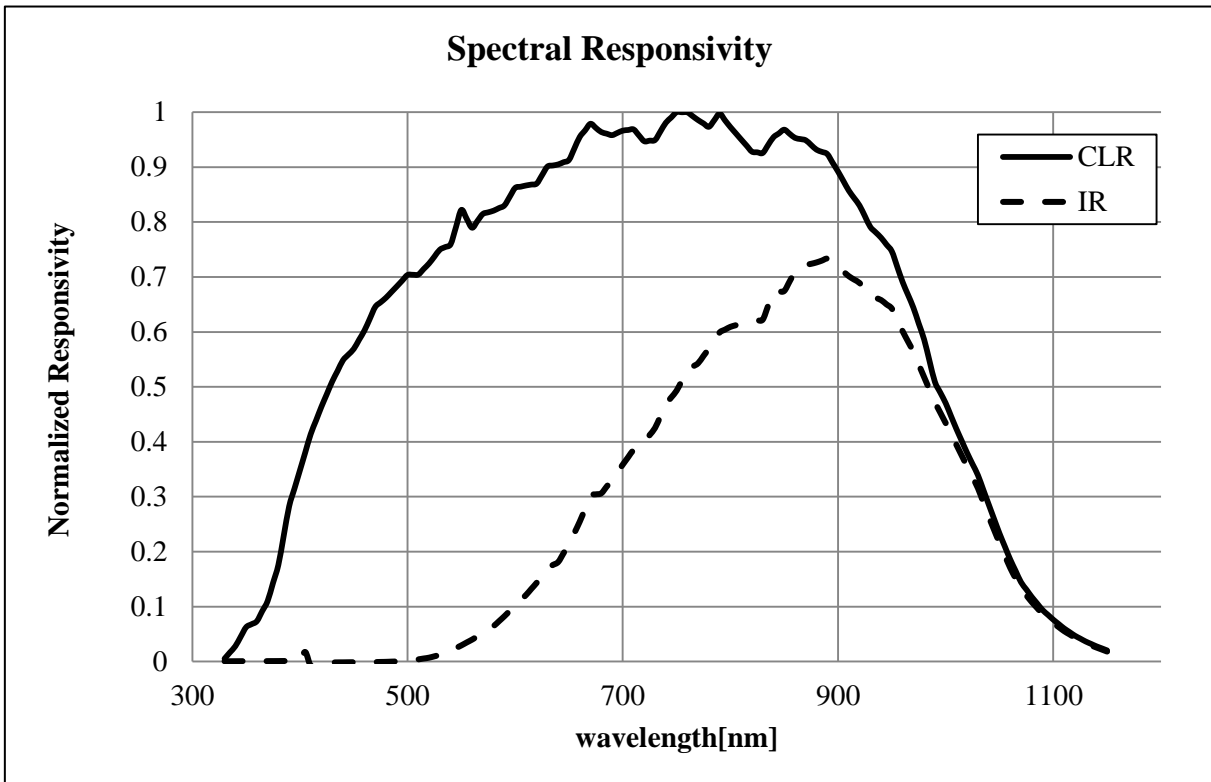

Fig.20 Spectral Responsivity

12.3. Proximity sensor (PS) mode

Sensor output counts vs. distance

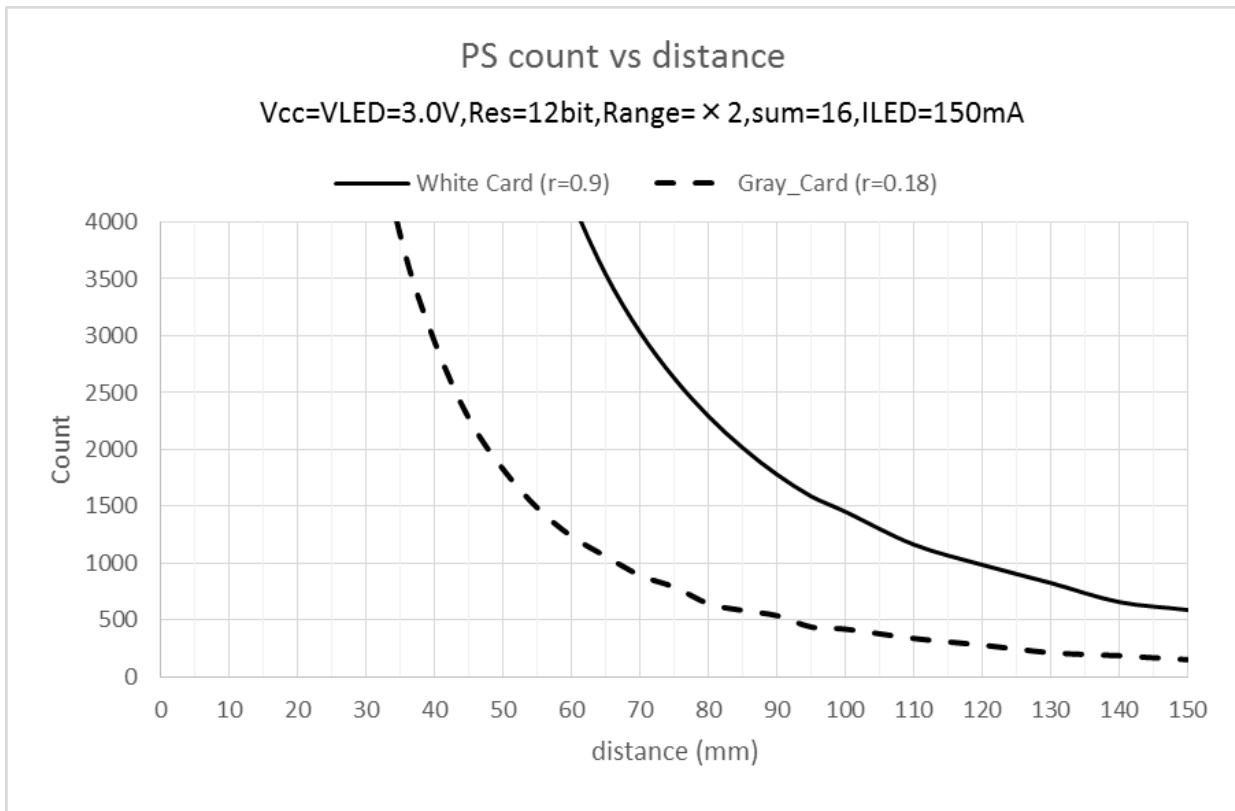

Fig.21 Sensor output counts vs. distance

12.4. Angular dependence

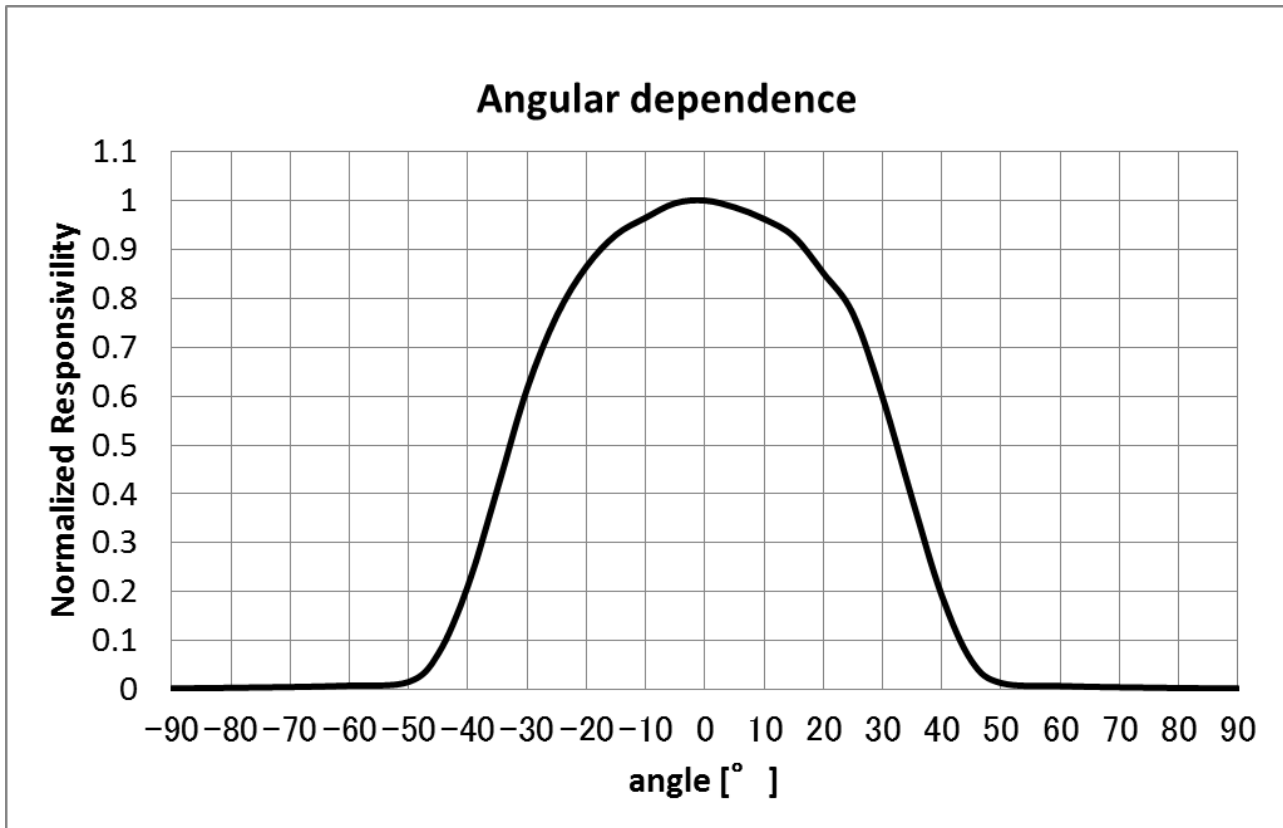

Fig.22 Angular dependence